

## CABLE PROTECTION CATEGORY

- WIRING DUCTS
- BUSHINGS
- CONDUITS AND FITTINGS
- TOOLS



**HUA WEI INDUSTRIAL CO., LTD.**  
Taiwan . China . Thailand

## PRODUCT OVERVIEW

### WIRING DUCTS



B-5  
Button Tubes

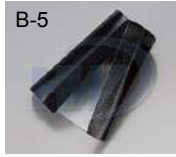

B-5  
Hook & Loop Tubes



B-6  
Wrapping Bands

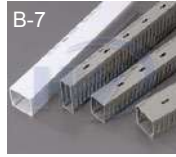

B-7  
Slotted/ Solid Wall  
Wiring Ducts



B-8  
Round Type Wiring  
Ducts



B-8  
Telephone Wiring  
Ducts



B-9  
One Piece  
Raceway



B-10  
Raceway  
Fittings

### BUSHINGS



B-14  
Strain Relief  
Bushings



B-15  
Open Bushings



B-15  
Washing Machine  
Cord Bushings



B-15  
Cable Clamps



B-16  
Hole Plugs



B-16  
Bushings



B-16  
Extruded Grommeting

### CONDUITS AND FITTINGS



B-21  
PA Flexible  
Conduits



B-21  
PE Flexible  
Conduits



B-22  
PP Flexible  
Conduits



B-22  
Five-Piece Conduit  
Adaptors



B-23  
Angle Type  
Conduit Adaptors



B-24  
Quick Disconnect  
Conduit Adaptors



B-25  
Conduit Mounting  
Brackets



B-26  
Cable Glands

### TOOLS



B-28  
Multi-Cutter



B-28  
Wiring Duct Cutter

# CABLE PROTECTION

WIRING DUCTS..... B-2  
BUSHINGS..... B-11  
CONDUITS AND FITTINGS..... B-17  
TOOLS ..... B-28



## INTRODUCTION OF HUA WEI'S WIRING DUCTS

Hua Wei's cable protection are applied to protect cables and wires from pressure, corrosion, and abrasion and to offer advantages of insulation, neat and keeping in order.

### The Length Is Cut Depending on Users' Need

Hua Wei's wiring ducts can cut the length with scissors/ tools. Button Tubes and Hoop & Loop Tubes can easily unwrapped and fold to storage. Wrapping Bands is very common accessory applying to arrangement of the cables. If needed, it is convenient for the wire to pull out from spiral to connect to other place. These cable protections apply widely from industrial control box, tele-communication cabinets, wire cable arrangement of factory office, and to household.

Hua Wei has wide range of wire ducts, which goes with UL certificate, are well known in the industry. The length can be cut by proper tools and applied by users' need. Wire ducts are widely applied to industrial control box, tele-communication cabinets, wire cable arrangement of factory/office.

### Full Range of Wiring Ducts for Electronic and Internal Decoration

Hua Wei's wiring ducts carry with UL certificate and are specially designed for applying to control panel. The features combine with high quality, rigid sidewall section, compact cover design, and variable sizes fully comply with global electronic regulation and the best choice for all kinds of control panels.

Hua Wei has complete series internal decoration raceway, includes Round type wiring ducts applied on floors; Telephone wiring ducts for protection of telephone line and internet cables. One piece raceway and Fittings are perfect solution for office furniture.



# MATERIAL & APPLICATION TABLE

Product Name	Button Tubes	Hook & Loop Tubes	Wrapping Bands	
Type	FBT	FMT	GST	
Page	B-5	B-5	B-6	
Material	Refractory a meshes mezzanine PVC. Button: POM	Refractory a meshes mezzanine PVC. Velcro: Polyamide	PE	PE Flame-retardant
<b>Operating Temperature</b>				
Max.	105°C (221°F)	105°C (221°F)	80°C (176°F)	80°C (176°F)
Min.	-25°C (-13°F)	-25°C (-13°F)	-40°C (-40°F)	-40°C (-40°F)
<b>Resistant Properties</b>				
UV light/ozone	○	○	△	△
Oils and greases	○	○	◎	◎
Solvents	○	○	○	○
Petrol	○	○	○	○
Moisture	○	○		
Flammability	UL94VTM-0	UL94VTM-0	UL94HB	UL94V-0
<b>Possible Applications</b>				
Switch cabinets	★	★	★	★
Machinery and equipment manufacture	★	★	★	★
Rail-borne vehicles	★	★	★	★
Petro/chemical industry	★	★	★	★
Offshore-industry	☆	☆	☆	☆
Telecommunications	★	★	★	★
Shipbuilding	☆	☆	★	★
Harnessmaker	★	★	★	★
Public building	★	★	☆	☆
Automobile industry	★	★	☆	☆
Household applicances	★	★	☆	☆
<b>Sample Applications</b>				
Bundling of cables and wires	★	★	★	★
Wiring in switchboards	★	★	★	★
Protection of wires	★	★	★	★
Chafing protection for cables	★	★	☆	☆
Plastic housings				

◎ Excellent ○ Good △ Medium ★ Suitable ☆ Partly Suitable

Cable Protection  
Wiring Ducts



# MATERIAL & APPLICATION TABLE

Product Name	Slotted/ Solid Wall Wiring Ducts	Round Type Wiring Ducts	Telephone Wiring Ducts	One Piece Raceway
Type	GW	GRD	GD	GU
Page	B-7	B-8	B-8	B-9
Material	PVC	PVC	PVC	PVC
<b>Operating Temperature</b>				
Max.	50°C (112°F)	50°C (112°F)	50°C (112°F)	50°C (112°F)
Min.	-25°C (-13°F)	-25°C (-13°F)	-25°C (-13°F)	-25°C (-13°F)
<b>Resistant Properties</b>				
UV light/ozone	○	○	○	○
Oils and greases	○	○	○	○
Solvents	○	○	○	○
Petrol	○	○	○	○
Moisture	○	○	○	○
Flammability	UL94V-0	UL94V-0	UL94V-0	UL94V-0
<b>Possible Applications</b>				
Switch cabinets	★			
Machinery and equipment manufacture	★			
Rail-borne vehicles	★			
Petro/chemical industry	★			
Offshore-industry	★			
Telecommunications	★	★	★	★
Shipbuilding	★	★	★	★
Harnessmaker				
Public building	★	★	★	★
Automobile industry				
Household appliances	★	★	★	★
<b>Sample Applications</b>				
Bundling of cables and wires	★	★	★	★
Wiring in switchboards	★	★	★	★
Protection of wires	★	★	★	★
Chafing protection for cables	★	★	★	★
Plastic housings				
Internal decoration	☆	★	★	★

◎ Excellent ○ Good △ Medium ★ Suitable ☆ Partly Suitable

Cable Protection  
Wiring Ducts

## BUTTON TUBES

- Good for cable wrapping and protection
- Easy to wrap and re-usable
- Thickness : 0.35mm
- Material: Refractory a meshes mezzanine PVC  
Button material : POM
- Color: Black, grey

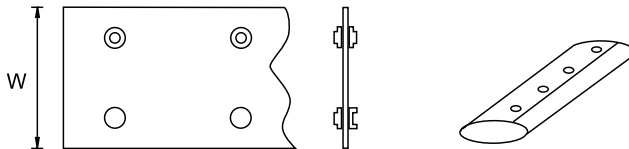

Part No.	Max.Bundle ø mm (inch)	Band Width (W) mm (inch)
FBT-10	10.0 (0.39)	55.0 (2.17)
FBT-15	15.0 (0.59)	75.0 (2.95)
FBT-20	20.0 (0.79)	90.0 (3.54)
FBT-25	25.0 (0.98)	100.0 (3.94)
FBT-30	30.0 (1.18)	115.0 (4.53)

Part No.	Max.Bundle ø mm (inch)	Band Width (W) mm (inch)
FBT-40	40.0 (1.57)	146.0 (5.75)
FBT-50	50.0 (1.97)	175.0 (6.89)
FBT-70	70.0 (2.76)	241.0 (9.49)
FBT-100	100.0 (3.94)	333.0 (13.11)

Cable Protection  
Wiring Ducts

## HOOK & LOOP TUBES

- Good for cable wrapping and protection
- Easy to wrap and re-usable
- Material: Refractory a meshes mezzanine PVC  
Velcro: Polyamide
- Color: Black, grey

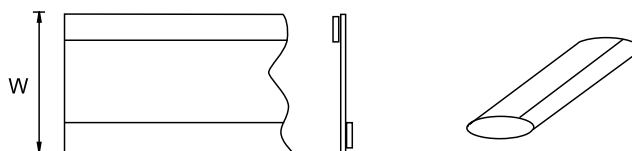

Part No.	Max.Bundle ø mm (inch)	Band Width (W) mm (inch)
FMT-15	15.0 (0.59)	75.0 (2.95)
FMT-20	20.0 (0.79)	90.0 (3.54)
FMT-25	25.0 (0.98)	107.0 (4.21)
FMT-30	30.0 (1.18)	123.0 (4.84)

Part No.	Max.Bundle ø mm (inch)	Band Width (W) mm (inch)
FMT-40	40.0 (1.57)	154.0 (6.06)
FMT-50	50.0 (1.97)	185.0 (7.28)
FMT-70	70.0 (2.76)	248.0 (9.76)
FMT-100	100.0 (3.94)	342.0 (13.46)

## WRAPPING BANDS

- Used for organizing and protecting cables and hoses
- The spiral structure allows cables to branch out at any point and in any direction
- P/N postfix V0 means the material is flame-retardant (UL94V-0)
- Material: PE
- Color: Natural, black

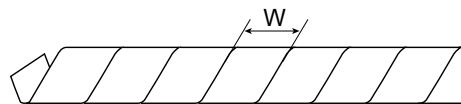

Part No.	In-Diameter mm (inch)	Out-Diameter mm (inch)	W mm (inch)	Wrapping Range mm (inch)
GST-4	5.0 (0.20)	6.0 (0.24)	7.0 (0.28)	4.0~50.0 (0.16~1.97)
GST-6	7.0 (0.28)	8.0 (0.31)	10.8 (0.43)	6.0~60.0 (0.24~2.36)
GST-8	8.5 (0.33)	10.0 (0.39)	11.4 (0.45)	7.5~60.0 (0.30~2.36)
GST-9	10.2 (0.40)	12.0 (0.47)	13.9 (0.55)	9.0~65.0 (0.35~2.56)
GST-12	13.0 (0.51)	15.0 (0.59)	15.0 (0.59)	12.0~70.0 (0.47~2.76)
GST-15	16.4 (0.65)	19.0 (0.75)	18.2 (0.72)	15.0~100.0 (0.59~3.94)
GST-20	21.0 (0.83)	24.0 (0.94)	19.6 (0.77)	20.0~130.0 (0.79~5.12)
GST-4-V0	5.0 (0.20)	6.0 (0.24)	7.0 (0.28)	4.0~50.0 (0.16~1.97)
GST-6-V0	7.0 (0.28)	8.0 (0.31)	10.8 (0.43)	6.0~60.0 (0.24~2.36)
GST-8-V0	8.5 (0.33)	10.0 (0.39)	11.4 (0.45)	7.5~60.0 (0.30~2.36)
GST-9-V0	10.2 (0.40)	12.0 (0.47)	13.9 (0.55)	9.0~65.0 (0.35~2.56)
GST-12-V0	13.0 (0.51)	15.0 (0.59)	15.0 (0.59)	12.0~70.0 (0.47~2.76)
GST-15-V0	16.4 (0.65)	19.0 (0.75)	18.2 (0.72)	15.0~100.0 (0.59~3.94)
GST-20-V0	21.0 (0.83)	24.0 (0.94)	19.6 (0.77)	20.0~130.0 (0.79~5.12)



# SLOTTED/ SOLID WALL WIRING DUCTS

- Easy and firm snap-on assembly, smooth joining for a better finish
- Solid wiring ducts without hole punctures are also available
- Manufactured with high quality rigid PVC with good insulation, flameretardant and heat resistant
- Material: PVC
- Length: 1.7M & 2.0M
- Color: White, grey, black, beige, blue

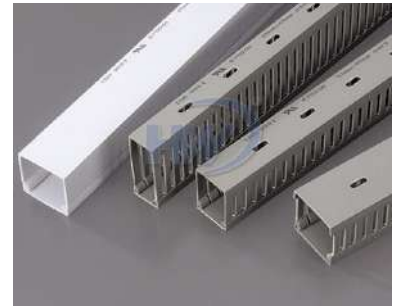

Part No.	Slot Hole Size			Width (W) mm (inch)	Height (H) mm (inch)	Wiring Volume	Mounting Hole Dimension	
	S	M	L					
GW-1525	S		L	15.0 (0.59)	25.0 (0.98)	5-12 PCS	Small	
GW-1616	S		L	16.0 (0.63)	16.0 (0.63)	5-12 PCS	Small	
GW-2020	S		L	20.0 (0.79)	20.0 (0.79)	5-12 PCS	Small	
GW-2060	S	M	L	20.0 (0.79)	60.0 (2.36)	5-12 PCS	Small	
GW-2516	S	M	L	25.0 (0.98)	16.0 (0.63)	5-12 PCS	Small	
GW-2525	S	M	L	25.0 (0.98)	25.0 (0.98)	10-25 PCS	Small	
* GW-2530	S		L	25.0 (0.98)	30.0 (1.18)	10-25 PCS	Small	
GW-2540	S	M	L	25.0 (0.98)	40.0 (1.57)	20-25 PCS	Small	
GW-2545	S	M	L	25.0 (0.98)	45.0 (1.77)	20-25 PCS	Small	
GW-2565	S	M	L	25.0 (0.98)	65.0 (2.56)	40-45 PCS	Small	
* GW-2580	S		L	25.0 (0.98)	80.0 (3.15)	100-120 PCS	Small	
* GW-3060	S			30.0 (1.18)	60.0 (2.36)	45-65 PCS	Small	
GW-3333	S	M	L	33.0 (1.30)	33.0 (1.30)	25-54 PCS	Small	
GW-3345	S	M	L	33.0 (1.30)	45.0 (1.77)	40-55 PCS	Small	
GW-3365	S	M	L	33.0 (1.30)	65.0 (2.56)	60-75 PCS	Small	
GW-33100	S		L	33.0 (1.30)	100.0 (3.94)	180-200 PCS	Small	
GW-3816	S	M	L	38.0 (1.50)	16.0 (0.63)	6-13PCS	Small	
GW-4025	S	M	L	40.0 (1.57)	25.0 (0.98)	20-25 PCS	Small	
GW-4040	S	M	L	J	40.0 (1.57)	40.0 (1.57)	60-70 PCS	Small
GW-4060	S	M	L	J	40.0 (1.57)	60.0 (2.36)	100-115 PCS	Small
GW-4080	S		L	J	40.0 (1.57)	80.0 (3.15)	120-135 PCS	Small
* GW-40100			L	40.0 (1.57)	100.0 (3.94)	180-210 PCS	Small	
GW-4545	S	M	L	45.0 (1.77)	45.0 (1.77)	60-70 PCS	Small	
GW-4565	S	M	L	45.0 (1.77)	65.0 (2.56)	110-120 PCS	Small	
GW-5050	S	M	L	J	50.0 (1.97)	50.0 (1.97)	80-90 PCS	Small
* GW-5080			L	50.0 (1.97)	80.0 (3.15)	160-180 PCS	Small	
GW-50100	S		L	50.0 (1.97)	100.0 (3.94)	210-260 PCS	Small	
GW-6040	S	M	L	60.0 (2.36)	40.0 (1.57)	100-115 PCS	Small	
GW-6060	S	M	L	J	60.0 (2.36)	60.0 (2.36)	120-135 PCS	Small
GW-6080	S		L	J	60.0 (2.36)	80.0 (3.15)	180-210 PCS	Small
* GW-60100			L	60.0 (2.36)	100.0 (3.94)	240-290 PCS	Small	
GW-6545	S	M	L	65.0 (2.56)	45.0 (1.77)	110-120 PCS	Small	
GW-6565	S	M	L	65.0 (2.56)	65.0 (2.56)	110-120 PCS	Small	
GW-70100	S		L	70.0 (2.76)	100.0 (3.94)	250-300 PCS	Large	
GW-7264	S		L	72.0 (2.83)	64.0 (2.52)	200-220 PCS	Large	
GW-8040			L	80.0 (3.15)	40.0 (1.57)	120-135 PCS	Large	
GW-8060	S		L	80.0 (3.15)	60.0 (2.36)	180-210 PCS	Large	
GW-8080	S		L	J	80.0 (3.15)	80.0 (3.15)	240-290 PCS	Large
* GW-80100	S		L	80.0 (3.15)	100.0 (3.94)	260-310 PCS	Large	
GW-10060	S		L	100.0 (3.94)	60.0 (2.36)	240-290 PCS	Large	
* GW-10080	S		L	100.0 (3.94)	80.0 (3.15)	260-310 PCS	Large	
GW-100100	S		L	J	100.0 (3.94)	100.0 (3.94)	300-400 PCS	Large
* GW-12080			L	120.0 (4.72)	80.0 (3.15)	290-390 PCS	Large	
GW-15075			L	150.0 (5.91)	75.0 (2.95)	335-500 PCS	Large	
* GW-200100			L	200.0 (7.87)	100.0 (3.94)	600-800 PCS	Large	

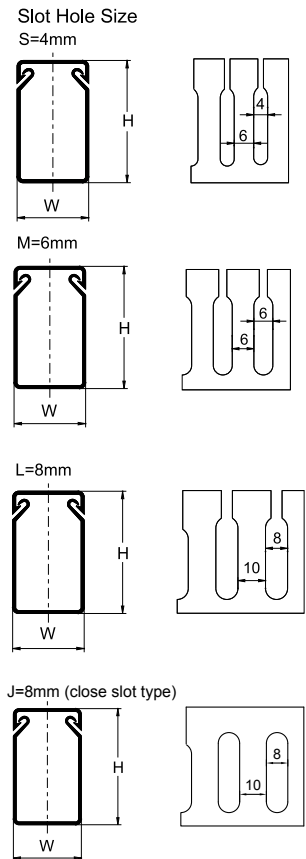

Mounting Hole Dimension  
Small Duct

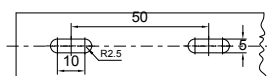

Large Duct

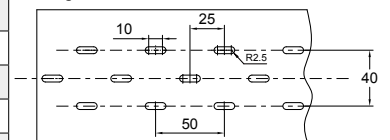

Cable Protection  
Wiring Ducts

\* Not included in UL E75050 accreditation. \*\* Wiring volume is base on wires of 2.0 sq. mm.

## ROUND TYPE WIRING DUCTS

- Backed with high quality double sided tape for permanent fixture
- Good for floor wiring to facilitate trolley pass and to avoid tripping, especially in public places, like shopping malls, hospitals, and stations
- Material: PVC
- Length: 1M
- Color: All colors are available

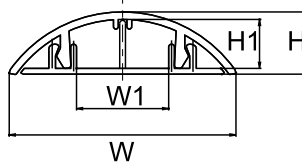

Part No.	W mm (inch)	W1 mm (inch)	H mm (inch)	H1 mm (inch)
GRD-20	20.0 (0.79)	8.0 (0.31)	6.0 (0.24)	4.0 (0.16)
GRD-30	30.0 (1.18)	11.0 (0.43)	8.0 (0.31)	6.0 (0.24)
GRD-40	39.0 (1.54)	16.0 (0.63)	10.0 (0.39)	8.0 (0.31)
GRD-50	49.0 (1.93)	24.0 (0.94)	12.0 (0.47)	9.0 (0.35)
GRD-60	58.0 (2.28)	30.0 (1.18)	12.0 (0.47)	9.0 (0.35)
GRD-70	68.0 (2.68)	39.0 (1.54)	14.0 (0.55)	11.0 (0.43)
GRD-90	90.0 (3.54)	45.0 (1.77)	19.0 (0.75)	15.0 (0.59)
GRD-120	120.0 (4.72)	70.0 (2.76)	25.0 (0.98)	21.0 (0.83)

## TELEPHONE WIRING DUCTS

- Smooth corners and edges that will not abrade wiring or irritate hands
- Integrated nonskid liners and unique cover designs insure the duct cover will not slide once installed or during vibration
- Specially formulated lead-free PVC material meet the flame retardant requirements
- Material: PVC
- Length: 1M
- Color: All colors are available

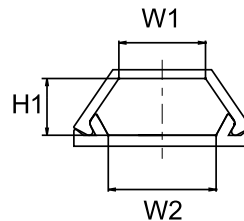

Part No.	W1 mm (inch)	W2 mm (inch)	H1 mm (inch)	Wire to be Contained
GD-1	10.0 (0.39)	9.0 (0.35)	5.0 (0.20)	1 PCS
GD-2	13.0 (0.51)	11.0 (0.43)	7.0 (0.28)	2-3 PCS
GD-3	12.0 (0.47)	14.0 (0.55)	10.0 (0.39)	3-4 PCS
GD-4	13.0 (0.51)	17.0 (0.67)	12.0 (0.47)	4-7 PCS
GD-5	13.0 (0.51)	19.0 (0.75)	17.0 (0.67)	7-9 PCS
GD-6	15.0 (0.59)	21.0 (0.83)	17.0 (0.67)	10-15 PCS
GD-8	28.0 (1.10)	35.0 (1.38)	17.0 (0.67)	30-40 PCS

\* Wiring volume is based on telephone lines of 0.8 mm in diameter.

# ONE PIECE RACEWAY

- One-piece duct and cover design provides quicker and more convenient routing
- To be applied with various special fittings, hiding wiring and cables routing in business space, office, and home, ideal for internal decoration and routing safety
- Design with adhesive backing, provides easy and faster installation
- The raceway is made from RoHS compliant PVC, offers excellent insulation as well as non-toxic for indoor use
- Flame retardant material be applied, conforms to UL94V-0 class, high temperature resistant up to 50°C
- Paintable surface perfectly matches with internal decoration
- Unique self-locking latch design ensures closure tightly without height difference
- Precise forming hinge endures 600,000 times of opening without cracking
- Material: PVC
- Color: White, ivory

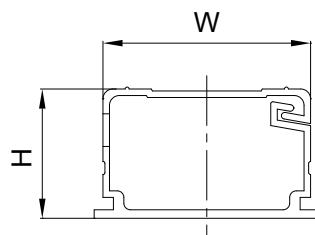

Part No.	W mm (inch)	H mm (inch)	Wiring Volume	Length M (ft.)
GU-2015	20.0 (0.79)	15.0 (0.59)	CAT 5e *6	1.8 (6.0)
			CAT 6 *4	
			CAT 6A FTP *2	
			25-Pair *1	
			6 Fiber *4	
			1 Fiber *16	
			Coax *3	
GU-3520	35.0 (1.38)	20.0 (0.79)	CAT 5e *15	1.8 (6.0)
			CAT 6 *10	
			CAT 6A FTP *6	
			25-Pair *4	
			6 Fiber *9	
			1 Fiber *39	
			Coax *7	
GU-4525	45.0 (1.77)	25.0 (0.98)	CAT 5e *29	1.8 (6.0)
			CAT 6 *19	
			CAT 6A FTP *11	
			25-Pair *7	
			6 Fiber *17	
			1 Fiber *72	
			Coax *14	

Cable Protection  
Wiring Ducts

# RACEWAY FITTINGS

- Material: FRHIPS
- Color: White, ivory

Type	Part No.	Suitable for Raceway
<b>Flat Elbow</b>	GUC-20LC	GU-2015
	GUC-35LC	GU-3520
	GUC-45LC	GU-4525
<b>Flat Elbow +Base</b>	GUC-20LA	GU-2015
	GUC-35LA	GU-3520
	GUC-45LA	GU-4525
<b>Tee</b>	GUC-20TC	GU-2015
	GUC-35TC	GU-3520
	GUC-45TC	GU-4525
<b>Tee + Base</b>	GUC-20TA	GU-2015
	GUC-35TA	GU-3520
	GUC-45TA	GU-4525
<b>Outside Corner Cover</b>	GUC-20OC	GU-2015
	GUC-35OC	GU-3520
	GUC-45OC	GU-4525

Type	Part No.	Suitable for Raceway
<b>Outside Corner Cover +Base</b>	GUC-20OA	GU-2015
	GUC-35OA	GU-3520
	GUC-45OA	GU-4525
<b>Inside Corner Cover</b>	GUC-20RX	GU-2015
	GUC-35RX	GU-3520
	GUC-45RX	GU-4525
<b>Joint cover</b>	GUC-20IX	GU-2015
	GUC-35IX	GU-3520
	GUC-45IX	GU-4525
<b>End Cap</b>	GUC-20EX	GU-2015
	GUC-35EX	GU-3520
	GUC-45EX	GU-4525
<b>Ceiling Entry +Clip</b>	GUC-20CA	GU-2015
	GUC-35CA	GU-3520
	GUC-45CA	GU-4525
<b>Reducer</b>	GUC-3520	(1-1/4" to 3/4")
	GUC-4520	(1-3/4" to 3/4")
	GUC-4535	(1-3/4" to 1-1/4")

Cable Protection Wiring Ducts



- 1 Ceiling Entry+Clip
- 5 Reducer
- 2 Flat Elbow+Base
- 6 Inside Corner Cover
- 3 Joint cover
- 7 Outside Corner Cover+Base
- 4 Tee + Base
- 8 End Cap

## INTRODUCTION OF HUA WEI'S BUSHINGS

### Edge Protection and Fixture

Hua Wei's strain relief bushings are recommended by its full product line and applicable for all kinds of small white goods and lamps. Strain relief bushing fixed on the outlet of power cord is to secure and prevent the wire from pull-off. Open bushings are available for multiple size. Open design is easy to apply to circular hole, and the surrounding design can be secured to protect the wire from abrasion and electrical short-cut. Extruded Grommets can cut by users' need and is very flexible to bend over. Thus, it's very convenient to apply on all kinds of circular and irregular holes.





# MATERIAL & APPLICATION TABLE

Product Name	Strain Relief Bushings	Open Bushings	Washing Machine Cord Bushings	Cable Clamps
Type	-	OB	SB-375-4	5462/10
Page	B-14	B-15	B-15	B-15
Material	Polyamide 6,6	Polyamide 6,6	Polyamide 6,6	Polyamide 6,6
<b>Operating Temperature</b>				
Max.	85°C (185°F)	85°C (185°F)	85°C (185°F)	85°C (185°F)
Min.	-40°C (-40°F)	-40°C (-40°F)	-40°C (-40°F)	-40°C (-40°F)
<b>Resistant Properties</b>				
UV light/ozone	△	△	△	△
Oils and greases	◎	◎	◎	◎
Solvents	○	○	○	○
Petrol	◎	◎	◎	◎
Moisture				
Flammability	UL94V-2	UL94V-2	UL94V-2	UL94V-2
<b>Possible Applications</b>				
Switch cabinets			☆	
Machinery and equipment manufacture			☆	
Rail-borne vehicles				
Petro/chemical industry				
Offshore-industry	★	★		★
Telecommunications				
Shipbuilding				
Harnessmaker				
Public building				
Automobile industry				
Household appliances	★	★	★	★
<b>Sample Applications</b>				
Mechanical Protection				
Cable Protection	☆	★	★	★
Chafing protection for cables	★	★	★	★
Plastic housings	★	★	★	★
Insulation of wires	☆	☆	☆	☆

◎ Excellent ○ Good △ Medium ★ Suitable ☆ Partly Suitable

Cable Protection Bushings

# MATERIAL & APPLICATION TABLE

Product Name	Hole Plugs	Bushings	Extruded Grommeting
Type	M-13	FO	GMB
Page	B-16	B-16	B-16
Material	Polyamide 6,6	Polyamide 6,6	PE
<b>Operating Temperature</b>			
Max.	85°C (185°F)	85°C (185°F)	80°C (176°F)
Min.	-40°C (-40°F)	-40°C (-40°F)	-40°C (-40°F)
<b>Resistant Properties</b>			
UV light/ozone	△	△	○
Oils and greases	◎	◎	○
Solvents	○	○	○
Petrol	◎	◎	△
Moisture			○
Flammability	UL94V-2	UL94V-2	UL94HB
<b>Possible Applications</b>			
Switch cabinets			☆
Machinery and equipment manufacture			★
Rail-borne vehicles			
Petro/chemical industry			☆
Offshore-industry			
Telecommunications	★	★	
Shipbuilding			
Harnessmaker			★
Public building			
Automobile industry	★		★
Household appliances	★	★	
<b>Sample Applications</b>			
Mechanical Protection			
Cable Protection	★	★	★
Chafing protection for cables	★	★	★
Plastic housings	★	★	★
Insulation of wires		☆	☆

◎ Excellent   ○ Good   △ Medium   ★ Suitable   ☆ Partly Suitable

Cable Protection  
Bushings

# STRAIN RELIEF BUSHINGS

- Designed to insulate and protect cables and cords
- Provide non-slip grip and will not injure insulation of AC cord
- Material: Polyamide 6,6, UL94V-2
- Color: Black

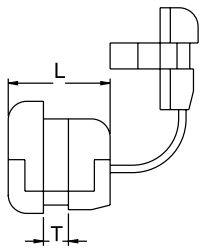
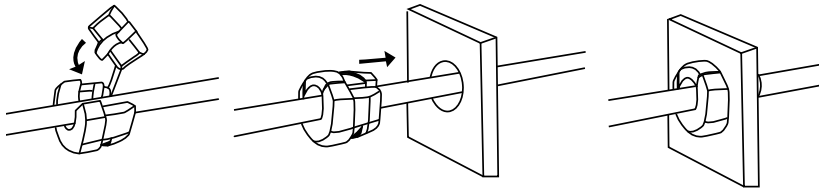

Maximum chassis thickness-part actually has additional clearance

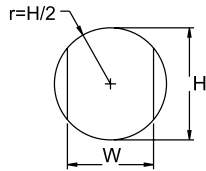

chassis dimensions

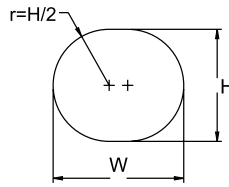

3W-1



Part No.	Cross Section Shape	Accommodated Wires		Mounting Holes		Max. Chassis Thickness T mm (inch)	Length L mm (inch)
		UL Wires	Approx. Wires Size mm (inch)	H mm (inch)	W mm (inch)		
2B-2	Flat	SPT-1 18/2	2.8x5.6 (0.11x0.22)	9.5 (0.37)	8.7 (0.34)	3.4 (0.13)	10.5 (0.41)
3B-1		SPT-1 18/2	3.1x5.6 (0.12x0.22)	10.3 (0.41)	12.3 (0.48)	1.6 (0.06)	10.3 (0.41)
3B-2		SPT-1 18/2	3.1x5.6 (0.12x0.22)	10.3 (0.41)	12.3 (0.48)	2.7 (0.11)	10.3 (0.41)
3W-1		SPT-2 18/3	3.8x10.2 (0.15x0.40)	9.5 (0.37)	16.0 (0.63)	2.4 (0.09)	11.9 (0.47)
4B-2		SPT-1 18/2	3.1x5.6 (0.12x0.22)	12.7 (0.50)	11.3 (0.44)	2.6 (0.10)	11.0 (0.43)
4L-2		SPT-2 18/2	3.1x7.6 (0.12x0.30)	12.7 (0.50)	11.5 (0.45)	2.6 (0.10)	10.5 (0.41)
4W-2		SPT-2 18/2	3.8x7.1 (0.15x0.28)	12.7 (0.50)	11.9 (0.47)	1.6 (0.06)	10.8 (0.43)
5B-2		Round	SVT 18/3	ø6.4~7.4 (0.25x0.29)	11.2 (0.44)	14.5 (0.57)	2.6 (0.10)
5W-2	AWM 24 64 22/12		ø6.4~7.4 (0.25x0.29)	12.5 (0.49)	11.5 (0.45)	1.6 (0.06)	11.1 (0.44)
6B3-2R	SJT 18/3		ø8.3~9.2 (0.32x0.36)	16.1 (0.63)	14.0 (0.55)	3.2 (0.13)	14.7 (0.58)
6B3-2S	SJT 18/3		ø8.3~9.2 (0.32x0.36)	16.1 (0.63)	14.0 (0.55)	3.2 (0.13)	14.7 (0.58)
6W3-4R	SJT 18/3		ø8.3~9.2 (0.32x0.36)	16.1 (0.63)	14.0 (0.55)	1.6 (0.06)	14.7 (0.58)
6W3-4S	SJT 18/3		ø8.3~9.2 (0.32x0.36)	16.1 (0.63)	14.0 (0.55)	1.6 (0.06)	14.7 (0.58)
7H-2	SJT 14/3		ø9.2~11.0 (0.36x0.43)	16.8 (0.66)	15.7 (0.62)	1.8 (0.07)	19.1 (0.75)
8H-2	SJT 12/3		ø13.5~15.3 (0.53x0.60)	21.1 (0.83)	19.5 (0.77)	3.5 (0.14)	20.7 (0.81)
9H-2	#18 20~30PCS		ø11.0~15.0 (0.43x0.59)	23.1 (0.91)	22.2 (0.87)	1.8 (0.07)	17.6 (0.69)



## OPEN BUSHINGS

- Protect power cord and smooth your chassis hole
- Easy installation, No tool is needed
- Can be applied after power cable was installed
- Material: Polyamide 6,6, UL94V-2
- Color: Black

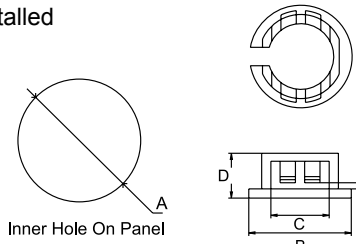

Part No.	A mm (inch)	B mm (inch)	C mm (inch)	D mm (inch)
OB-12	ø12.7 (0.50)	ø16.8 (0.66)	ø10.8 (0.43)	7.3 (0.29)
OB-16	ø15.9 (0.63)	ø20.3 (0.80)	ø14.1 (0.56)	7.3 (0.29)
OB-19	ø19.0 (0.75)	ø22.5 (0.89)	ø16.5 (0.65)	7.3 (0.29)
OB-20	ø19.5 (0.77)	ø26.0 (1.02)	ø20.0 (0.79)	7.2 (0.28)
OB-21	ø22.2 (0.87)	ø24.6 (0.97)	ø19.2 (0.76)	7.5 (0.30)
OB-22	ø22.0 (0.87)	ø26.0 (1.02)	ø20.0 (0.79)	7.3 (0.29)

## WASHING MACHINE CORD BUSHINGS

- The cord bushings are designed to insulate and protect electrical cords of washing machine
- Provide non-slip grip and will not injure insulation of AC cord
- Material: Polyamide 6,6, UL94V-2
- Color: Black

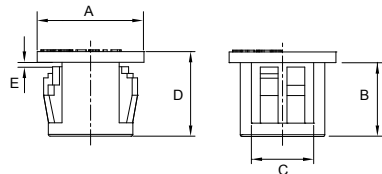

Part No.	A mm (inch)	B mm (inch)	C mm (inch)	D mm (inch)	E mm (inch)
SB-375-4	ø12 (0.47)	6.8 (0.27)	ø7.0 (0.28)	9.5 (0.37)	0.7 (0.03)

## CABLE CLAMPS

- Acting as a bushing to protect the cable, a stress relief to avoid pulling the wires from their connections and the possibility to terminate the cables, the cable clamps restraints are simple to install using just one screw
- Material: Polyamide 6,6, UL94V-2
- Color: Natural, black

Unit: mm (inch)

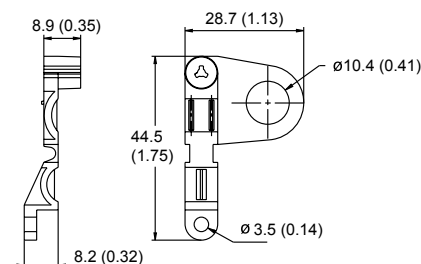

Part No.: 5462/10



## HOLE PLUGS

- Hole in chassis : 12.7~13 mm
- Easy installation, no tool is required
- Ideal for closing panel cavity
- Material: Polyamide 6,6, UL94V-2
- Color: Black

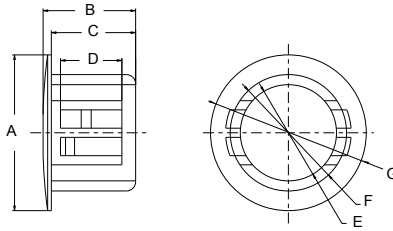

Part No.	A mm (inch)	B mm (inch)	C mm (inch)	D mm (inch)	E mm (inch)	F mm (inch)	G mm (inch)
M-13	ø17.0 (0.67)	10.1 (0.40)	9.2 (0.36)	6.7 (0.26)	ø10.5 (0.41)	ø12.7 (0.50)	ø14.6 (0.57)

## BUSHINGS

- Application for lighting and electric equipment
- Protect electrical cable against rough hole edges
- Material: Polyamide 6,6, UL94V-2
- Color: Black

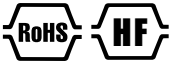
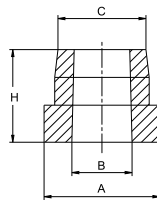

Part No.	A mm (inch)	B mm (inch)	C mm (inch)	H mm (inch)
FO-31	ø12.3 (0.48)	ø7.1 (0.28)	ø9.1 (0.36)	5.9 (0.23)
FO-45	ø12.4 (0.49)	ø6.5 (0.26)	ø9.4 (0.37)	9.8 (0.39)

## EXTRUDED GROMMETING

- Applied to the panel edge easily without the need for adhesives
- The close-fitting profile provides effective protection for cables by preventing any chafing
- Material: PE
- Color: Natural

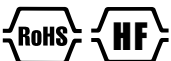

Part No.	Duct Dia. mm (inch)	Panel Thickness mm (inch)
GMB-10	1.0 (0.04)	below 1.0 (0.04)
GMB-16	1.6 (0.06)	1.0~1.6 (0.04~0.06)
GMB-20	2.0 (0.08)	1.6~2.0 (0.06~0.08)
GMB-24	2.4 (0.09)	2.0~2.4 (0.08~0.09)
GMB-32	3.2 (0.13)	2.4~3.2 (0.09~0.13)
GMB-45	4.5 (0.18)	3.2~4.5 (0.13~0.18)



## INTRODUCTION OF HUA WEI'S CONDUIT AND FITTING SERIES

Hua Wei's conduit and fitting series are applicable for temperature between  $-40^{\circ}\text{C}$  up to  $85^{\circ}\text{C}$ , resistant to solvents, liquid-tight, or with silicone cover – no matter which protective system you require, Hua Wei will certainly have a solution for your request.

You will find our products in the mechanical engineering sector, in wind power stations, or in the automotive. They keep electromagnetic impacts away from data lines, they protect laser light guides against physical impacts, or they guarantee easy stability for tools and instruments in the medical sector. So if it is about protective tubing systems, we will take well care of you- in a competent, comprehensive, and innovative way.

Hua Wei's cable glands comply with IP68 standard, and are applying UL certification. Cable glands are ideal for fixing cables of machines, electrical applications, mechanical control boards/ boxes.



## REFERENCE FOR CONDUIT AND FITTING SERIES

Nominal Dimension		Conduits			Conduit Adaptors			Mounting Brackets	
mm	inch	PA 6	PE	PP	Five-Piece	Angle Type	Quick-Fixed	U Type	Capped
6.4	1/4"	NFC-07	EFC-07	PFC-07	FC5-07	FCL-07	--	XFN-07	XFW-07
7.9	5/16"	NFC-10	EFC-10	PFC-10	FC5-10	FCL-10	--	XFN-10	XFW-10
9.5	3/8"	NFC-12	EFC-12	PFC-12	FC5-12	FCL-12	FCG-12	XFN-12	XFW-12
12.7	1/2"	NFC-17	EFC-17	PFC-17	FC5-17	FCL-17	FCG-17	XFN-17	XFW-17
19.1	3/4"	NFC-23	EFC-23	PFC-23	FC5-23	FCL-23	FCG-23	XFN-23	XFW-23
25.4	1"	NFC-28	EFC-28	PFC-28	FC5-28	FCL-28	FCG-28	XFN-28	XFW-28
31.8	1 1/4"	NFC-36	EFC-36	PFC-36	FC5-36	FCL-36	FCG-36	XFN-36	XFW-36
50.8	2"	NFC-48	EFC-48	PFC-48	FC5-48	FCL-48	FCG-48	XFN-48	XFW-48

## COMPARISON FOR MATERIAL OF CONDUITS

Material	PA 6	PE	PP
<b>Properties</b>			
Temperature range	○	○	○
Flexibility	○	◎	○
Cross pressure strength	○	○	◎
Tensile strength	○	△	○
Bending radius	△	◎	◎
Oil resistance	○	◎	◎
Solvent resistance	○	○	○
Alternate bending strength	◎	◎	◎
Flame resistance	◎	○ ( △ )	○ ( △ )
Density of smoke	◎	○	○

◎ Excellent ○ Good △ Medium

# MATERIAL & APPLICATION TABLE

Product Name	PA Flexible Conduits	PE Flexible Conduits	PP Flexible Conduits	Five-Piece Conduit Adaptors
Type	NFC	EFC	PFC	FC5
Page	B-21	B-21	B-22	B-22
Material	Polyamide 6	PE	PP	Polyamide 6,6
<b>Operating Temperature</b>				
Max.	85°C (185°F)	80°C (176°F)	70°C (156°F)	85°C (185°F)
Min.	-40°C (-40°F)	-40°C (-40°F)	-20°C (-4°F)	-40°C (-40°F)
<b>Resistant Properties</b>				
UV light/ozone	○	△	△	△
Oils and greases	○	◎	◎	◎
Solvents	○	○	○	○
Petrol	○	○	○	◎
Flammability	UL94V-2	UL94HB	UL94HB	UL94V-2
<b>Possible applications</b>				
Switch cabinets	★	★	★	★
Machinery and equipment manufacture	★	★	★	★
Rail-borne vehicles	★	★	★	★
Petro/chemical industry	★	★	★	★
Offshore-industry				☆
Telecommunications				★
Shipbuilding				★
Harnessmaker	★	★	★	★
Robotics industry	★	★	★	★
Public building	★	★	★	☆
Automobile industry	★	★	★	
Aerospace industry				
Household application	★	★	★	★
<b>Sample applications</b>				
Bundling of cables and wires				
Wiring in switchboards				★
Protection of wires	★	★	★	★
Chafing protection for cables				
Insulation of wires	★	★	★	★
Fastenings of ducts				

◎ Excellent   ○ Good   △ Medium   ★ Suitable   ☆ Partly Suitable

Cable Protection  
Conduits & Fittings

# MATERIAL & APPLICATION TABLE

Product Name	Angle Type Conduit Adaptors	Quick-Disconnect Conduit Adaptors	Conduit Mounting Brackets	Cable Glands
Type	FCL	FCG	XFN, XFW	PG, M, NPT
Page	B-23	B-24	B-25	B-26 / B-27
Material	Polyamide 6,6	Polyamide 6,6	Polyamide 6,6	Polyamide 6,6
<b>Operating Temperature</b>				
Max.	85°C (185°F)	85°C (185°F)	85°C (185°F)	85°C (185°F)
Min.	-40°C (-40°F)	-40°C (-40°F)	-40°C (-40°F)	-40°C (-40°F)
<b>Resistant Properties</b>				
UV light/ozone	△	△	△	△
Oils and greases	◎	◎	◎	◎
Solvents	○	○	○	○
Petrol	◎	◎	◎	◎
Flammability	UL94V-2	UL94V-2	UL94V-2	UL94V-2
<b>Possible applications</b>				
Switch cabinets	★	★	★	★
Machinery and equipment manufacture	★	★	★	★
Rail-borne vehicles	★	★	★	★
Petro/chemical industry	★	★	★	★
offshore-industry	☆	☆	☆	☆
Telecommunications	★	★	★	★
Shipbuilding	★	★	★	★
Harnessmaker	★	★	★	★
Robotics industry	★	★	★	★
Public building	☆	☆	☆	☆
Automobile industry				
Aerospace industry				
Household application	★	★	★	★
<b>Sample applications</b>				
Bundling of cables and wires				
Wiring in switchboards	★	★	★	★
Protection of wires	★	★	★	★
Chafing protection for cables				★
Insulation of wires	★	★		
Fastenings of ducts			★	

◎ Excellent   ○ Good   △ Medium   ★ Suitable   ☆ Partly Suitable

## PA FLEXIBLE CONDUITS

- Applicable on electrical, machinery, and building harness wiring
- Flexibility for installation while providing protection to cables
- Fluid resistance
- Material: Polyamide 6, UL94V-2
- Color: Black

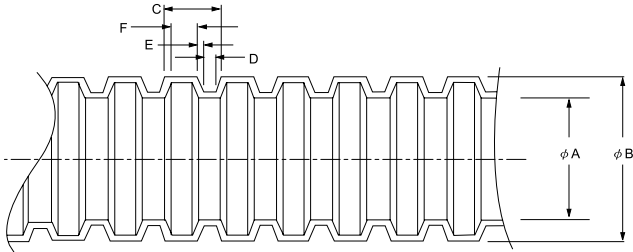

Part No.	Nominal Dimension		In-Diameter A mm (inch)	Outer-Diameter B mm (inch)	C mm (inch)	D mm (inch)	E mm (inch)	F mm (inch)
	mm	inch						
NFC-07	6.4	1/4"	ø6.8±0.4 (0.27±0.02)	ø10.0±0.4 (0.39±0.02)	2.7 (0.11)	0.6 (0.02)	0.3 (0.01)	1.5 (0.06)
NFC-10	7.9	5/16"	ø9.6±0.4 (0.38±0.02)	ø13.0±0.4 (0.51±0.02)	2.9 (0.12)	0.6 (0.02)	0.3 (0.01)	1.7 (0.07)
NFC-12	9.5	3/8"	ø12.0±0.4 (0.47±0.02)	ø15.8±0.4 (0.62±0.02)	3.2 (0.13)	0.7 (0.03)	0.3 (0.01)	1.9 (0.07)
NFC-17	12.7	1/2"	ø16.2±0.4 (0.64±0.02)	ø21.2±0.4 (0.83±0.02)	3.5 (0.14)	0.6 (0.02)	0.4 (0.02)	2.1 (0.08)
NFC-23	19.1	3/4"	ø21.9±0.4 (0.86±0.02)	ø28.5±0.4 (1.12±0.02)	4.8 (0.19)	0.8 (0.03)	0.5 (0.02)	3.0 (0.12)
NFC-28	25.4	1"	ø27.6±0.4 (1.09±0.02)	ø34.5±0.4 (1.36±0.02)	4.8 (0.19)	0.9 (0.03)	0.6 (0.02)	2.7 (0.11)
NFC-36	31.8	1 1/4"	ø36.0±0.4 (1.42±0.02)	ø42.5±0.4 (1.67±0.02)	6.4 (0.25)	1.2 (0.05)	0.8 (0.03)	3.7 (0.15)
NFC-48	50.8	2"	ø47.0±0.4 (1.85±0.02)	ø54.5±0.4 (2.15±0.02)	6.4 (0.25)	1.1 (0.04)	0.8 (0.03)	3.8 (0.15)

## PE FLEXIBLE CONDUITS

- Applicable on electrical, machinery, and building harness wiring
- Flexibility for installation while providing protection to cables
- Fluid resistance
- Material: PE
- Color: Black, other colors are also available

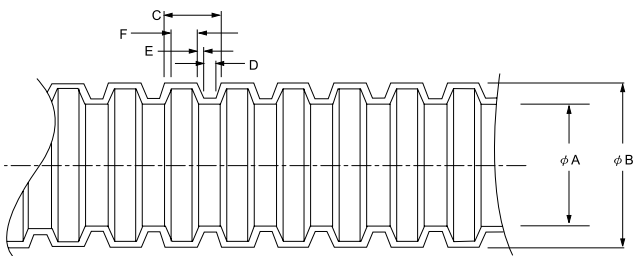

Part No.	Nominal Dimension		In-Diameter A mm (inch)	Outer-Diameter B mm (inch)	C mm (inch)	D mm (inch)	E mm (inch)	F mm (inch)
	mm	inch						
EFC-07	6.4	1/4"	ø6.8±0.4 (0.27±0.02)	ø10.0±0.4 (0.39±0.02)	2.7 (0.11)	0.6 (0.02)	0.3 (0.01)	1.5 (0.06)
EFC-10	7.9	5/16"	ø9.6±0.4 (0.38±0.02)	ø13.0±0.4 (0.51±0.02)	2.9 (0.12)	0.6 (0.02)	0.3 (0.01)	1.7 (0.07)
EFC-12	9.5	3/8"	ø12.0±0.4 (0.47±0.02)	ø15.8±0.4 (0.62±0.02)	3.2 (0.13)	0.7 (0.03)	0.3 (0.01)	1.9 (0.07)
EFC-17	12.7	1/2"	ø16.2±0.4 (0.64±0.02)	ø21.2±0.4 (0.83±0.02)	3.5 (0.14)	0.6 (0.02)	0.4 (0.02)	2.1 (0.08)
EFC-23	19.1	3/4"	ø21.9±0.4 (0.86±0.02)	ø28.5±0.4 (1.12±0.02)	4.8 (0.19)	0.8 (0.03)	0.5 (0.02)	3.0 (0.12)
EFC-28	25.4	1"	ø27.6±0.4 (1.09±0.02)	ø34.5±0.4 (1.36±0.02)	4.8 (0.19)	0.9 (0.03)	0.6 (0.02)	2.7 (0.11)
EFC-36	31.8	1 1/4"	ø36.0±0.4 (1.42±0.02)	ø42.5±0.4 (1.67±0.02)	6.4 (0.25)	1.2 (0.05)	0.8 (0.03)	3.7 (0.15)
EFC-48	50.8	2"	ø47.0±0.4 (1.85±0.02)	ø54.5±0.4 (2.15±0.02)	6.4 (0.25)	1.1 (0.04)	0.8 (0.03)	3.8 (0.15)

# PP FLEXIBLE CONDUITS

- Applicable on electrical, machinery, and building harness wiring
- Flexibility for installation while providing protection to cables
- Fluid resistance
- Cut open products are also available
- Material: PP
- Color: Black

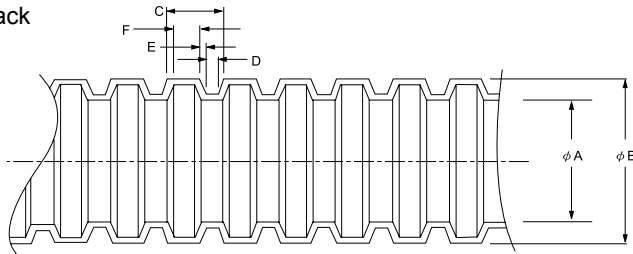

Part No.	Nominal Dimension		In-Diameter A mm (inch)	Outer-Diameter B mm (inch)	C mm (inch)	D mm (inch)	E mm (inch)	F mm (inch)
	mm	inch						
PFC-07	6.4	1/4"	ø6.8±0.4 (0.27±0.02)	ø10.0±0.4 (0.39±0.02)	2.7 (0.11)	0.6 (0.02)	0.3 (0.01)	1.5 (0.06)
PFC-10	7.9	5/16"	ø9.6±0.4 (0.38±0.02)	ø13.0±0.4 (0.51±0.02)	2.9 (0.12)	0.6 (0.02)	0.3 (0.01)	1.7 (0.07)
PFC-12	9.5	3/8"	ø12.0±0.4 (0.47±0.02)	ø15.8±0.4 (0.62±0.02)	3.2 (0.13)	0.7 (0.03)	0.3 (0.01)	1.9 (0.07)
PFC-17	12.7	1/2"	ø16.2±0.4 (0.64±0.02)	ø21.2±0.4 (0.83±0.02)	3.5 (0.14)	0.6 (0.02)	0.4 (0.02)	2.1 (0.08)
PFC-23	19.1	3/4"	ø21.9±0.4 (0.86±0.02)	ø28.5±0.4 (1.12±0.02)	4.8 (0.19)	0.8 (0.03)	0.5 (0.02)	3.0 (0.12)
PFC-28	25.4	1"	ø27.6±0.4 (1.09±0.02)	ø34.5±0.4 (1.36±0.02)	4.8 (0.19)	0.9 (0.03)	0.6 (0.02)	2.7 (0.11)
PFC-36	31.8	1 1/4"	ø36.0±0.4 (1.42±0.02)	ø42.5±0.4 (1.67±0.02)	6.4 (0.25)	1.2 (0.05)	0.8 (0.03)	3.7 (0.15)
PFC-48	50.8	2"	ø47.0±0.4 (1.85±0.02)	ø54.5±0.4 (2.15±0.02)	6.4 (0.25)	1.1 (0.04)	0.8 (0.03)	3.8 (0.15)

## FIVE-PIECE CONDUIT ADAPTORS

- Insert conduit into claw and screw in the sealing nut for fastening, then insert the body into the board and fix with lock nut
- Applied without tools make work more efficient
- Suitable for fixing wires of machines, mechanical control boards/ boxes and prevent from dust and water
- Material: Polyamide 6,6, UL94V-2. Washer: NBR
- Color: Black

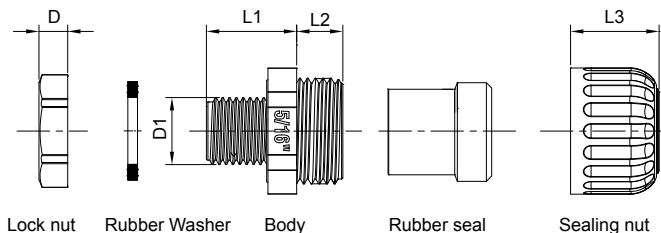

Part No.	Thread (PF)	Suitable Conduits	D mm (inch)	D1 mm (inch)	L1 mm (inch)	L2 mm (inch)	L3 mm (inch)
FC5-07	1/4"	NFC-07	5.6 (0.22)	ø13.1 (0.51)	17.6 (0.69)	8.5 (0.33)	17.0 (0.67)
FC5-10	1/4"	NFC-10	5.6 (0.22)	ø13.1 (0.51)	17.6 (0.69)	9.0 (0.35)	17.3 (0.68)
FC5-12	3/8"	NFC-12	5.6 (0.22)	ø16.6 (0.65)	17.5 (0.69)	10.8 (0.43)	18.0 (0.71)
FC5-17	1/2"	NFC-17	6.4 (0.25)	ø20.9 (0.82)	17.5 (0.69)	10.8 (0.43)	18.6 (0.73)
FC5-23	3/4"	NFC-23	6.5 (0.26)	ø26.3 (1.04)	17.8 (0.70)	11.5 (0.45)	20.7 (0.81)
FC5-28	1"	NFC-28	7.5 (0.30)	ø33.1 (1.30)	21.5 (0.85)	11.7 (0.46)	20.9 (0.82)
FC5-36	1-1/4"	NFC-36	7.5 (0.30)	ø42.2 (1.66)	22.5 (0.89)	15.0 (0.59)	24.8 (0.98)
FC5-48	2"	NFC-48	8.5 (0.33)	ø59.5 (2.34)	28.5 (1.12)	14.5 (0.57)	27.8 (1.09)



# ANGLE TYPE CONDUIT ADAPTORS

- Insert conduit into claw and screw in the sealing nut for fastening. Insert the body into the board and fix with lock nut
- 90 degree design suitable for corner application
- Applied without tools make work more efficient
- Suitable for fixing wires of machines, mechanical control boards/ boxes and prevent from dust and water
- Material: Polyamide 6,6, UL94V-2. Washer: NBR
- Color: Black

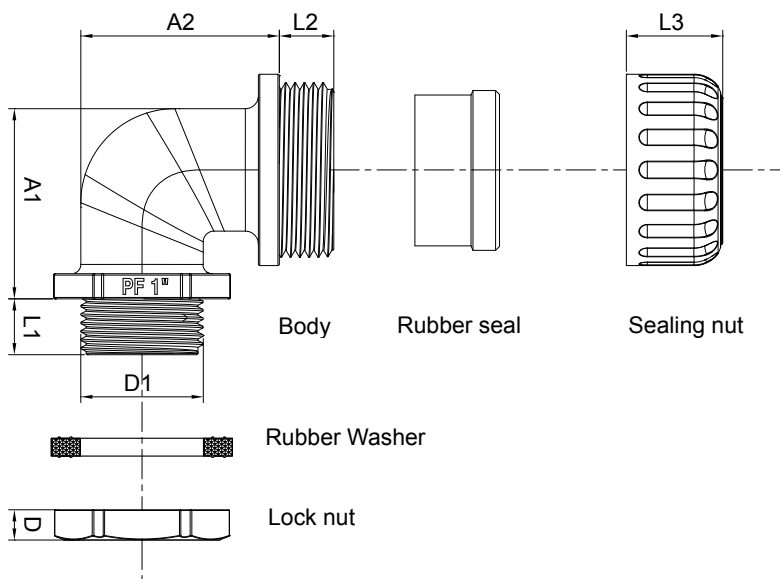

Cable Protection  
Conduits & Fittings

**IP68** 

Part No.	Thred (PF)	Suitable Conduits	D mm (inch)	D1 mm (inch)	L1 mm (inch)	A1 mm (inch)	A2 mm (inch)	L2 mm (inch)	L3 mm (inch)
FCL-07	1/4"	NFC-07	5.6 (0.22)	ø12.9 (0.51)	12.0 (0.47)	25.6 (1.01)	24.5 (0.96)	8.5 (0.33)	17.0 (0.67)
FCL-10	1/4"	NFC-10	5.6 (0.22)	ø12.9 (0.51)	12.1 (0.48)	27.9 (1.10)	26.9 (1.06)	9.0 (0.35)	17.3 (0.68)
FCL-12	3/8"	NFC-12	5.6 (0.22)	ø16.5 (0.65)	12.0 (0.47)	29.8 (1.17)	29.3 (1.15)	9.4 (0.37)	18.0 (0.71)
FCL-17	1/2"	NFC-17	6.4 (0.25)	ø20.7 (0.81)	12.0 (0.47)	37.1 (1.46)	34.2 (1.34)	11.5 (0.45)	18.6 (0.73)
FCL-23	3/4"	NFC-23	6.5 (0.26)	ø26.3 (1.04)	12.5 (0.49)	40.9 (1.61)	42.7 (1.68)	12.2 (0.48)	20.7 (0.82)
FCL-28	1"	NFC-28	7.5 (0.30)	ø33.2 (1.31)	15.3 (0.60)	49.7 (1.95)	51.5 (2.03)	12.4 (0.49)	20.9 (0.82)
FCL-36	1-1/4"	NFC-36	7.5 (0.30)	ø41.9 (1.65)	15.0 (0.59)	63.1 (2.48)	68.6 (2.70)	15.0 (0.59)	24.8 (0.98)
FCL-48	2"	NFC-48	8.5 (0.33)	ø59.5 (2.34)	20.0 (0.79)	87.0 (3.43)	89.0 (3.50)	14.5 (0.57)	27.8 (1.09)

## QUICK DISCONNECT CONDUIT ADAPTORS

- Push-in lock design makes connection and disconnection quick and energy-saving
- Simple dismounting the conduit from adaptor by pressing the snap-in sleeve
- Smallest outer dimensions to be used under confined conditions
- For machine, train, elevator...etc., where the maintenance need to be quick and perfectly done
- Material: Polyamide 6,6, UL94V-2
- Color: Black



Disconnect

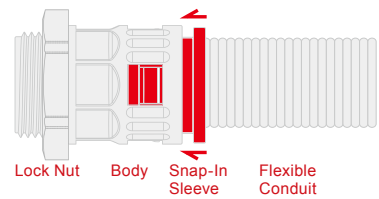
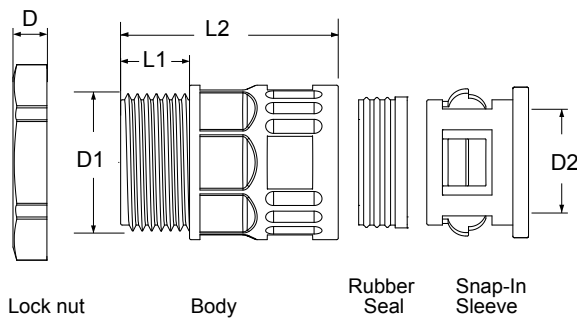

Press The Snap-In Sleeve & Pull Out

**IP68** 

Part No.	Thread (PF)	Suitable Conduits	D mm (inch)	D1 mm (inch)	D2 mm (inch)	L1 mm (inch)	L2 mm (inch)
FCG-12	1/2"	NFC-12	5.6 (0.22)	Ø20.8 (0.82)	Ø16.0 (0.63)	9.5 (0.37)	34.5 (1.36)
FCG-17	1/2"	NFC-17	6.5 (0.26)	Ø20.8 (0.82)	Ø22.2 (0.87)	11.7 (0.46)	40.0 (1.57)
FCG-23	3/4"	NFC-23	6.5 (0.26)	Ø26.3 (1.04)	Ø29.2 (1.15)	13.5 (0.53)	44.2 (1.74)
FCG-28	1"	NFC-28	7.5 (0.30)	Ø33.1 (1.30)	Ø35.6 (1.40)	13.5 (0.53)	46.3 (1.82)
FCG-36	1-1/4"	NFC-36	7.5 (0.30)	Ø41.5 (1.63)	Ø43.3 (1.70)	17.4 (0.69)	50.4 (1.98)
FCG-48	2"	NFC-48	8.5 (0.33)	Ø59.5 (2.34)	Ø55.0 (2.17)	15.5 (0.61)	51.5 (2.03)

# CONDUIT MOUNTING BRACKETS

- Apply for fixing the conduits. With screw on the bottom to fix on wall or ceil
- Applicable for joint together for multiple conduits
- U type is easy to clip and unfasten
- The cap design can secure the fixed of conduits
- Material: Polyamide 6,6, UL94V-2
- Color: Black



U Type

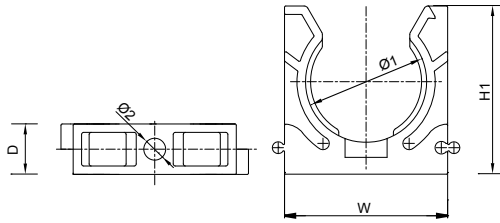

Capped Type

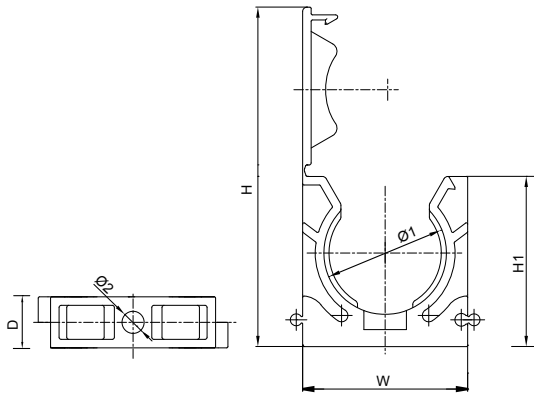

Cable Protection  
Conduits & Fittings



Part No.		Nominal Dimension		Suitable Conduits	W mm (inch)	H mm (inch)	H1 mm (inch)	D mm (inch)	Ø 1 mm (inch)	Ø 2 mm (inch)	Mounting Screw
U Type	Capped	mm	inch								
XFN-07	XFW-07	6.4	1/4"	NFC-07	19.5 (0.77)	40.9 (1.61)	20.6 (0.81)	10.0 (0.39)	Ø10.1 (0.40)	Ø4.5 (0.18)	M4 x15-30
XFN-10	XFW-10	7.9	5/16"	NFC-10	22.5 (0.89)	46.8 (1.84)	23.5 (0.93)	10.0 (0.39)	Ø13.2 (0.52)	Ø4.5 (0.18)	M4 x15-30
XFN-12	XFW-12	9.5	3/8"	NFC-12	25.4 (1.00)	52.4 (2.06)	26.2 (1.03)	10.0 (0.39)	Ø16.0 (0.63)	Ø4.5 (0.18)	M4 x15-30
XFN-17	XFW-17	12.7	1/2"	NFC-17	31.0 (1.22)	63.0 (2.48)	31.0 (1.22)	10.0 (0.39)	Ø21.5 (0.85)	Ø4.5 (0.18)	M4 x15-30
XFN-23	XFW-23	19.1	3/4"	NFC-23	38.8 (1.53)	79.8 (3.14)	40.0 (1.57)	12.0 (0.47)	Ø28.8 (1.13)	Ø5.5 (0.22)	M5 x15-30
XFN-28	XFW-28	25.4	1"	NFC-28	47.0 (1.85)	94.6 (3.72)	46.2 (1.82)	12.0 (0.47)	Ø34.8 (1.37)	Ø5.5 (0.22)	M5 x15-30
XFN-36	XFW-36	31.8	1-1/4"	NFC-36	55.8 (2.20)	113.3 (4.46)	56.0 (2.20)	16.0 (0.63)	Ø42.8 (1.69)	Ø6.2 (0.24)	M6 x15-30
XFN-48	XFW-48	50.8	2"	NFC-48	70.0 (2.76)	140.1 (5.52)	68.2 (2.69)	20.0 (0.79)	Ø54.8 (2.16)	Ø6.5 (0.26)	M6 x15-30

# CABLE GLANDS

- Time saving, cable can be easily once inserted into through the gland without dismantling the parts
- Suggested clearance hole for non-threaded mounting
- Suitable for fixing wires of machines, electrical applications, mechanical control boards/ boxes
- The gland can stand the temp. up to 140°C (284°F) in short time
- Material: Polyamide 6,6, UL94V-2. Neoprene for seal insert, with nut
- Color: Black, grey, light grey



## PG Gland/ Metric Gland

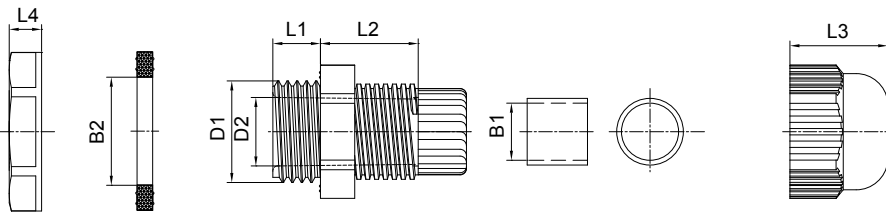

Lock nut   Rubber Washer   Body   Rubber Seal   Sealing Nut



Part No.	Mounting Hole Ø mm (inch)	D1 mm (inch)	D2 mm (inch)	B1 mm (inch)	B2 mm (inch)	L1 mm (inch)	L2 mm (inch)	L3 mm (inch)	L4 mm (inch)	Cord Range (mm <sup>2</sup> )
<b>PG Gland Range</b>										
PG-07	ø13.0 (0.51)	ø12.5 (0.49)	ø7.5 (0.30)	ø7.2 (0.28)	ø12.5 (0.49)	8.0 (0.31)	14.5 (0.57)	13.0 (0.51)	5.0 (0.20)	3.0~6.5
PG-09	ø15.7 (0.62)	ø15.2 (0.60)	ø10.0 (0.39)	ø9.9 (0.39)	ø15.2 (0.60)	8.0 (0.31)	15.5 (0.61)	15.3 (0.60)	5.0 (0.20)	4.0~8.0
PG-11	ø19.1 (0.75)	ø18.6 (0.73)	ø13.5 (0.53)	ø13.1 (0.52)	ø18.6 (0.73)	8.0 (0.31)	17.0 (0.67)	17.5 (0.69)	5.0 (0.20)	5.0~10.0
PG-13.5	ø20.9 (0.82)	ø20.4 (0.80)	ø13.5 (0.53)	ø13.1 (0.52)	ø20.4 (0.80)	10.0 (0.39)	17.0 (0.67)	17.5 (0.69)	6.0 (0.24)	6.0~12.0
PG-16	ø23.0 (0.91)	ø22.5 (0.89)	ø17.5 (0.69)	ø17.0 (0.67)	ø22.5 (0.89)	10.0 (0.39)	19.0 (0.75)	19.5 (0.77)	6.0 (0.24)	10.0~14.0
PG-21	ø28.8 (1.13)	ø28.3 (1.11)	ø21.4 (0.84)	ø21.0 (0.83)	ø28.3 (1.11)	10.0 (0.39)	21.2 (0.83)	25.0 (0.98)	7.0 (0.28)	13.0~18.0
PG-29	ø37.5 (1.48)	ø37.0 (1.46)	ø28.8 (1.13)	ø28.0 (1.10)	ø37.0 (1.46)	11.0 (0.43)	23.4 (0.92)	25.5 (1.00)	7.0 (0.28)	18.0~25.0
PG-36	ø47.5 (1.87)	ø47.0 (1.85)	ø36.5 (1.44)	ø35.3 (1.39)	ø47.0 (1.85)	12.0 (0.47)	27.8 (1.09)	30.0 (1.18)	8.0 (0.31)	22.0~32.0
PG-42	ø54.5 (2.15)	ø54.0 (2.13)	ø38.5 (1.52)	ø38.0 (1.50)	ø54.0 (2.13)	14.6 (0.57)	31.0 (1.22)	32.0 (1.26)	8.0 (0.31)	28.2~38.0
PG-48	ø59.8 (2.35)	ø59.3 (2.33)	ø46.0 (1.81)	ø45.5 (1.79)	ø59.3 (2.33)	15.5 (0.61)	30.6 (1.20)	34.5 (1.36)	8.0 (0.31)	35.0~45.0



Part No.	Mounting Hole Ø mm (inch)	D1 mm (inch)	D2 mm (inch)	B1 mm (inch)	B2 mm (inch)	L1 mm (inch)	L2 mm (inch)	L3 mm (inch)	L4 mm (inch)	Cord Range (mm <sup>2</sup> )
<b>Metric Gland Range</b>										
M12	ø12.5 (0.49)	ø12.5 (0.49)	ø7.5 (0.30)	ø7.2 (0.28)	ø12.5 (0.49)	8.0 (0.31)	14.5 (0.57)	13.0 (0.51)	5.0 (0.20)	3.0~6.5
M16	ø16.5 (0.65)	ø16.5 (0.65)	ø11.0 (0.43)	ø9.9 (0.39)	ø16.5 (0.65)	7.5 (0.30)	15.5 (0.61)	15.3 (0.60)	5.0 (0.20)	4.0~8.0
M20	ø20.5 (0.81)	ø20.5 (0.81)	ø17.5 (0.69)	ø17.0 (0.67)	ø20.5 (0.81)	10.0 (0.39)	19.0 (0.75)	19.5 (0.77)	6.0 (0.24)	10.0~14.0
M25	ø25.5 (1.00)	ø25.5 (1.00)	ø21.4 (0.84)	ø21.0 (0.83)	ø25.5 (1.00)	11.0 (0.43)	21.2 (0.83)	25.0 (0.98)	6.0 (0.24)	13.0~18.0
M32	ø32.5 (1.28)	ø32.5 (1.28)	ø27.0 (1.06)	ø28.0 (1.10)	ø32.5 (1.28)	10.3 (0.41)	23.4 (0.92)	25.5 (1.00)	7.0 (0.28)	18.0~25.0
M40	ø40.5 (1.59)	ø40.5 (1.59)	ø36.5 (1.44)	ø35.3 (1.39)	ø40.5 (1.59)	12.0 (0.47)	27.8 (1.09)	30.0 (1.18)	7.0 (0.28)	23.8~31.4
M50	ø50.5 (1.99)	ø50.5 (1.99)	ø38.5 (1.52)	ø38.0 (1.50)	ø50.5 (1.99)	12.0 (0.47)	31.0 (1.22)	32.0 (1.26)	8.0 (0.31)	27.3~38.4
M63	ø63.5 (2.50)	ø63.5 (2.50)	ø46.0 (1.81)	ø45.5 (1.79)	ø63.5 (2.50)	15.5 (0.61)	30.6 (1.20)	34.5 (1.36)	8.0 (0.31)	35.0~45.0

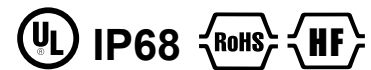

Part No.	Thread (NPT)	D1 mm (inch)	D2 mm (inch)	B1 mm (inch)	L1 mm (inch)	L2 mm (inch)	L3 mm (inch)	Cord Range (mm <sup>2</sup> )
<b>NPT Gland Range</b>								
EN-12A	3/8"	ø17.1 (0.20)	ø18.3 (0.33)	ø9.0 (0.35)	13.0 (0.51)	15.1 (0.20)	17.2 (0.28)	4.0~7.0
EN-12B	3/8"	ø17.1 (0.20)	ø18.3 (0.33)	ø11.0 (0.04)	13.0 (0.51)	15.1 (0.20)	17.2 (0.28)	6.0~10.0
EN-17A	1/2"	ø21.2 (0.87)	ø22.3 (0.09)	ø12.0 (0.08)	15.0 (0.59)	16.8 (0.27)	19.2 (0.36)	8.0~11.0
*EN-17B	1/2"	ø21.2 (0.87)	ø22.3 (0.09)	ø14.0 (0.16)	15.0 (0.59)	16.8 (0.27)	19.2 (0.36)	8.7~14.5
EN-23A	3/4"	ø26.6 (2.24)	ø28.2 (0.32)	ø17.0 (0.28)	15.0 (0.59)	20.3 (0.01)	22.6 (0.10)	10.0~16.0
EN-23B	3/4"	ø26.6 (2.24)	ø28.2 (0.32)	ø19.7 (0.38)	15.0 (0.59)	20.3 (0.01)	22.6 (0.10)	12.5~18.0
*EN-28A	1"	ø33.2 (0.91)	ø37.0 (0.28)	ø23.6 (0.14)	17.0 (0.67)	20.5 (0.02)	26.4 (0.25)	16.7~20.8
*EN-28B	1"	ø33.2 (0.91)	ø37.0 (0.28)	ø26.6 (0.26)	17.0 (0.67)	20.5 (0.02)	26.4 (0.25)	18.7~25.8
*EN-36A	1-1/4"	ø42.0 (3.86)	ø52.0 (0.08)	ø28.6 (0.34)	17.0 (0.67)	27.8 (0.31)	30.0 (1.18)	20.7~25.8
*EN-36B	1-1/4"	ø42.0 (3.86)	ø52.0 (0.08)	ø35.3 (0.21)	17.0 (0.67)	27.8 (0.31)	30.0 (1.18)	23.8~28.1

\* UL certified.

**NPT Gland**

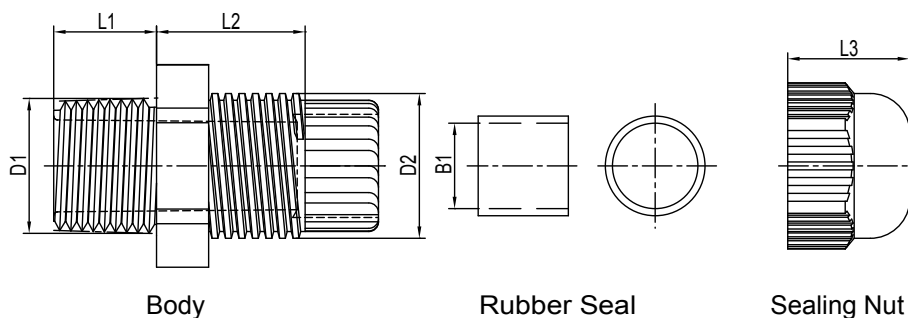

## MULTI-CUTTER



### GIT-302

- Carbon steel body with phosphatic finishing
- SK-5 carbon steel blade with HRC 54±2° heat treatment, chrome-plated, thickness:3mm
- Cutting board material: Polyamide with 45~50% Fiber
- Applicable to cut all angled objects
- Multi-purpose for household and other special use
- With lock latch
- Bolt and spanner is enclosed for replacing the blade
- Nontoxic handle with environmental concept
- Max. operating diameter: 80 mm (3.15 inch)
- Features: 1.Lever editing  
2. Effort saving 25~30%

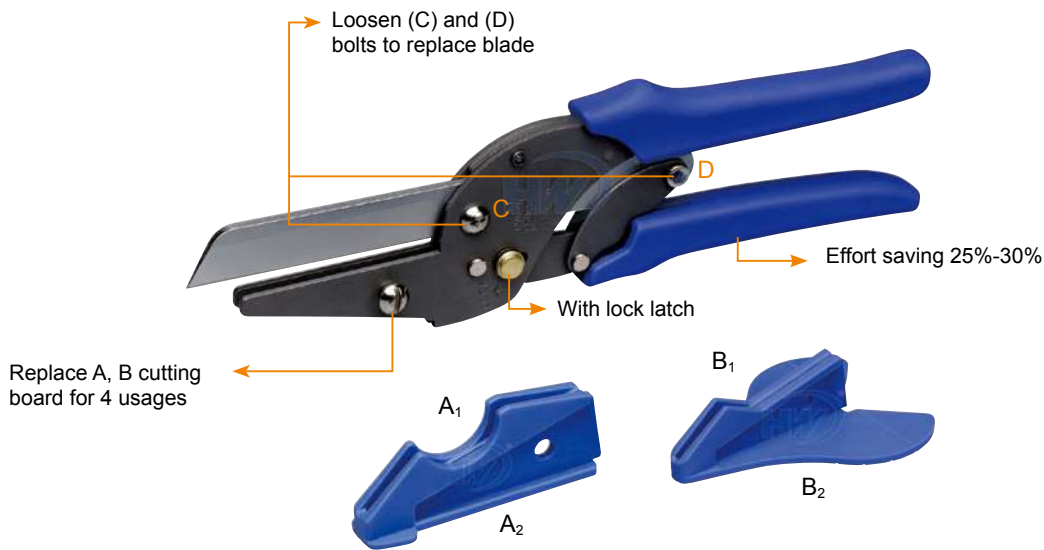

Apply to use on flexible conduit or PVC hose



It cuts easily the braided hose, water pipe, anti-pressure pipe and raceway

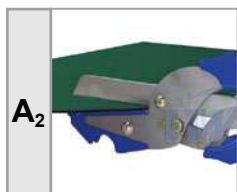

It perfectly cuts the cardboard or large sized flexible conduit



Perfect to cut angled objects (0°~45°), angle engraving on two side for both with left and right hands user

## WIRING DUCT CUTTER



### GIT-301

- Unique force-saving design, enable to cut stiff object
- User-friendly, only pull the handle and fix the object, then continue the force till the object is cut-off
- Stainless steel blade increases the life span when in use
- Blade: Molybdenum vanadium stainless steel
- Handle: Alloy aluminum ADC-12
- Max. operating diameter: 38 mm (1.50 inch)

**FASTENING SYSTEM**  
CABLE TIES

For more information, please visit:  
[www.hwlok.com](http://www.hwlok.com)



**STAINLESS STEEL TIES**



**ENGINEERING FASTENERS**



**FASTENERS**



**TOOLS CABLE MARKERS**



**WIRE TERMINATION**

**WIRE CONNECTORS**



**CORD-END TERMINALS**



**TERMINALS**

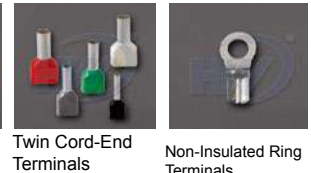

**TERMINALS**



**TERMINAL BLOCKS**

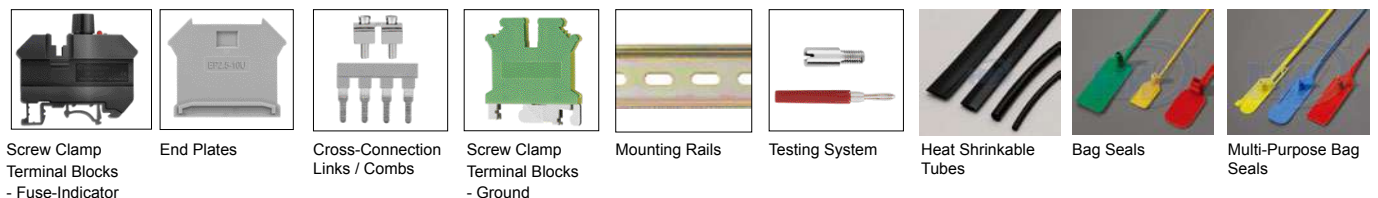
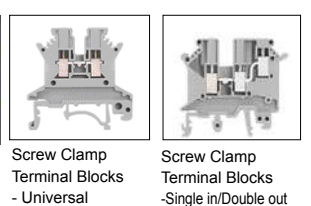

**SECURITY SEALS**

\* Tefzel® is a registered trademark of E.T. du Pont de Nemours and Company.



Hua Wei Industrial Co., Ltd. is a leading manufacturer of wire and cable management products in the world. Since 1976, Hua Wei has delivered excellence by consistently providing customers with extraordinary quality, first-class customer service, competitive pricing, and timely delivery. With rich experience and expertise, Hua Wei's global reach and presence is unmatched in the industry.

Headquartered in Taichung Taiwan, Hua Wei has expanded its manufacturing operations overseas in China and Thailand that are vertically integrated in design, manufacturing, processing, assembly, and packaging, thus expediting its response to changes in customer needs and market requirements. Moreover, all of Hua Wei manufacturing facilities are certified to ISO/TS16949, ISO9001, and ISO14001, complying with top-level quality systems and minimizing environmental impacts.

Hua Wei offers exceptional service combined with a large selection of products for a variety of applications in electrical, electronics, telecommunications, automotive, shipbuilding, rail, energy, construction, and retailing industries. In addition, to meet industry needs and market requirements, Hua Wei's products have gained UL, CE, CSA, ABS, DNV GL, BV and CQC accreditations and are all compliant with RoHS and REACH regulations.

Building its competitive advantage upon the core goals of innovation, continuous improvement and complete customer satisfaction, Hua Wei always spares no effort in advanced research and development to maintain its leading position and continually invests in its manufacturing operations to ensure customers receive the highest quality products and services.



## HUA WEI INDUSTRIAL CO., LTD.

### HEADQUARTERS

NO.1, GONGYEQU 26TH RD., NANTUN DIST.,  
TAICHUNG CITY, 40850, TAIWAN  
TEL: +886-4-23597777  
FAX: +886-4-23596705~6  
Email: [service@hwlok.com](mailto:service@hwlok.com)  
<http://www.hwlok.com>

### FACTORIES

Taichung, Taiwan  
Dongguan, China  
Chonburi, Thailand  
Rayong, Thailand