



FASTENING SYSTEM CATEGORY

- CABLE TIES
- STAINLESS STEEL TIES
- ENGINEERING FASTENERS
- FASTENERS
- TOOLS
- CABLE MARKERS
- COMBO PACKS



HUA WEI INDUSTRIAL CO., LTD.
Taiwan . China . Thailand



PRODUCT OVERVIEW

CABLE TIES



STAINLESS STEEL TIES



ENGINEERING FASTENERS

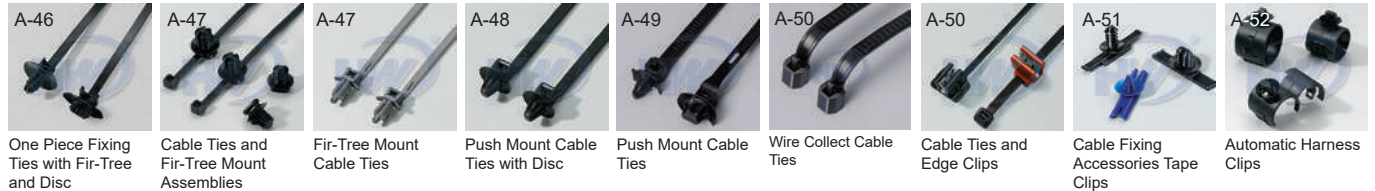

TOOLS



CABLE MARKERS

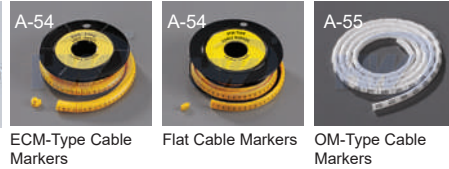

FASTENERS

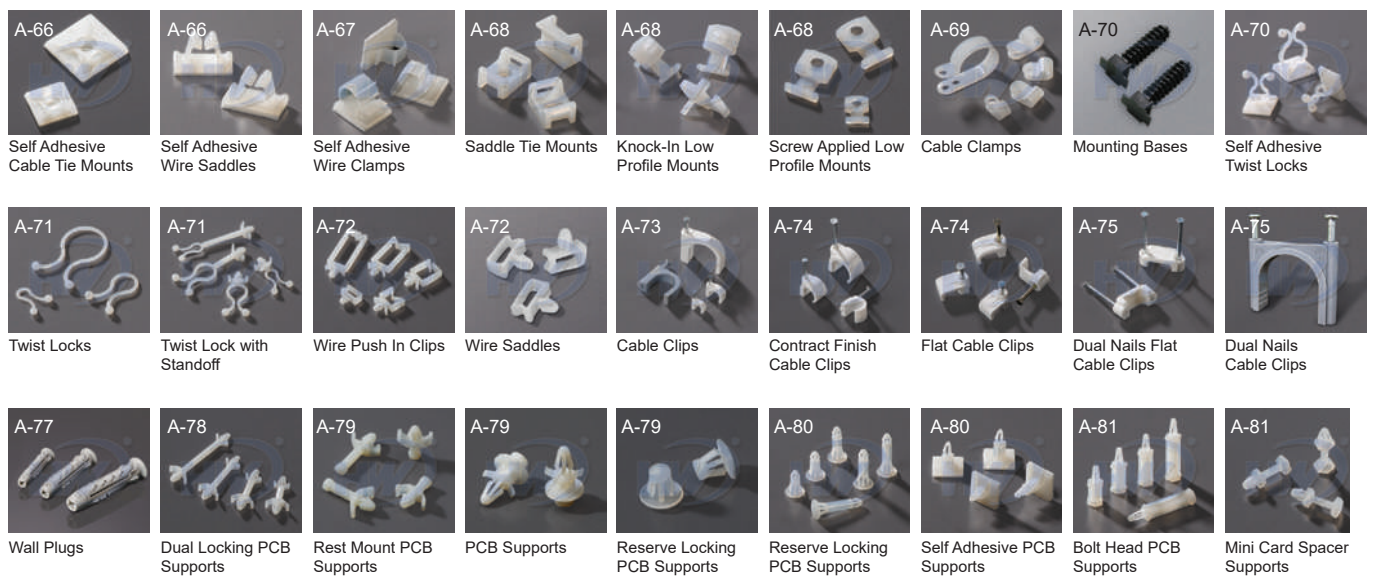

COMBO PACKS

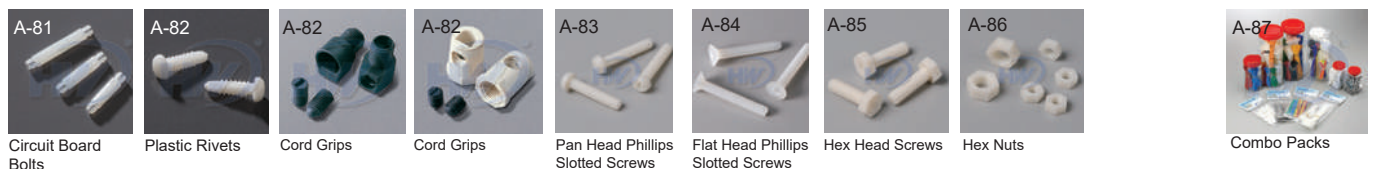

FASTENING SYSTEM

CABLE TIES.....	A-2
STAINLESS STEEL TIES.....	A-31
ENGINEERING FASTENERS.....	A-42
TOOLS	A-53
CABLE MARKERS.....	A-54
FASTENERS	A-56
COMBO PACKS.....	A-87

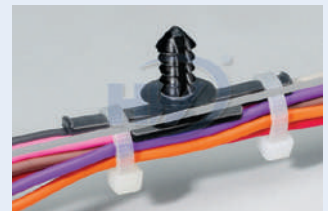

PROPERTIES OF MATERIAL

Properties of Polyamide 6,6 (PA66)

Polyamides are among the most important thermoplastic synthetic materials. Thermoplastics can be reshaped by heating as often as required without undergoing chemical decomposition or other negative changes. This makes polyamide ideal for processing via injection moulding into high quality products. About 90% of cable ties and fixings from Hua Wei are made from this material. Polyamide is also known as Nylon®.

The inner structure of polyamide displays a partial order of polymer chains, i.e. polyamides are partially crystalline. Due to the tighter packing of the individual molecular chains polyamide only has limited transparency to light. The plastic is therefore described as translucent.

The molecular chains of PA66 are made from two base units:

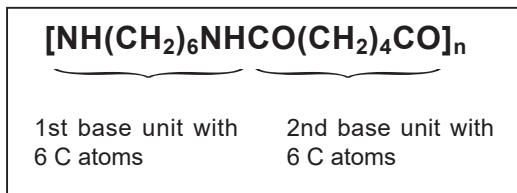

Each base unit contains 6 carbon atoms (C). Hence the name PA66. The polyamide PA66 has many properties which are highly advantageous for Hua Wei cable ties and fixings, such as:

- High strength, rigidity and hardness
- High dimensional stability, even under the effect of heat
- High abrasion resistance

Having a wide range of polyamides and additives allows for an optimum adaptation of the properties of the finished product to suit the respective requirements.

The following PA66 variants are used for Hua Wei products:

- Polyamide 6,6 standard for temperature conditions of up to +85°C
- Polyamide 6,6 Heat Stabilised for temperature conditions of up to +105°C
- Polyamide 6,6 UV Stabilised for exterior use
- Polyamide 6,6 Heat Stabilised and UV Stabilised for exterior use up to +105°C

- Polyamide 6,6 Impact Resistant for high elasticity requirements
- Polyamide 6,6 impact Resistant and Heat Stabilised for high elasticity requirements and temperatures up to +105°C
- Polyamide 6,6 V0 for high standards of fire protection.

Properties of UV-Stabilised Polyamide

The question constantly arises as to whether a black cable tie is suitable for use outside. This is dependant on the application of the tie, but in general the following statements can be made:

A black cable tie made of polyamide 6,6 standard (PA66) is only colored black with a low proportion of carbon black. This is not sufficient to protect the material from damage caused by UV-radiation in the long term.

Products made from UV-stabilised polyamide 6,6 are produced in accordance with ASTM standard D6779. So they resist UV-radiation in the European area for a considerably longer period than standard PA66.

For outdoor use, therefore, we recommend our range of products made from UV-Stabilised polyamide.

After 500 hours of UV- radiation exposure, polyamide 6,6 standard (PA66) dyed black and polyamide 6,6 UV-stabilised are totally different.

Polyamide 6,6 standard (PA66) dyed black:

The joint has been damaged throughout by UV-radiation.

Polyamide 6,6 UV-stabilised (PA66 UV):

The joint has only been altered at isolated points by the UV-radiation.

Properties of Polyamide 12 (PA12)

Apart from PA66, there are polyamides which are less hygroscopic. These include PA12, which has a molecular chain made of a base unit with 12 carbon atoms:

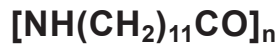

PA12 has the following advantages over PA66:

- Less hygroscopic - saturation at 23°C and 50% relative humidity is approximately 1%.
- Better impact performance.
- Good weather resistance, even without a special additive.

These three properties make PA12 ideal for use outdoors, in particularly when requirements may include impact resistance.

The water absorption of PA12 is not only less than that of PA66 but also slower. This is the requirement where the mechanical properties need to remain relatively unaffected by changing environmental conditions.

Properties of Tefzel®

ETFE can be best described as a rugged thermoplastic with an outstanding balance of properties. Mechanically, it is tough, has medium stiffness, impact and abrasion resistance.

Summary of key properties:

- No load continuous use temperature of 170°C.
- Weather resistant
- Inert to most solvents and chemicals
- Hydrolytically stable
- Substantially better resistance to radiation than other plastic materials.

ETFE can perform successfully in applications where other materials are lacking in mechanical toughness, broad thermal capability, ability to meet severe environmental conditions.

Tefzel® is a registered trademark of E.T. du Pont de Nemours and Company.

Water content in polyamide

Polyamide is a hygroscopic material – this means that it absorbs and releases water. The mechanical properties are significantly affected by the water content - especially flexibility and minimum tensile strength.

In a standard atmosphere of 23°C and 50% relative humidity, the degree of water saturation of polyamide is around 2.5%. For optimal processing of cable ties it is therefore important that the polyamide has a water content of approximately 2.5% in a state of equilibrium.

The quality and functionality of the products are thus affected by the water content, therefore the correct storage of our products is crucial. Please read our separate instructions on storage. (page.A-9)

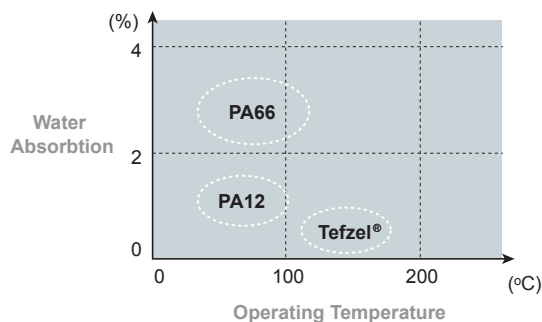

Since humidity is so critical to the quality of the tie, the question arises: What happens if the tie is installed and the water content in the tie alters?

The water content determines the flexibility and strength of a tie. At a water content of approximately 2.5% the tie has the ideal flexibility for installation. When the strap is being threaded through the head of the tie, the pawl must be flexible enough to seesaw over the serration of the strap without breaking. On the other hand, there must also be adequate material rigidity for the serrations of the pawl to engage with the serrations of the strap during the tying process so that a 'positive locking' action is achieved. After achieving the positive locking action the tie is in a static condition. Changes in the mechanical properties of the tie as a function of water content are insignificant during this status.

CHEMICAL RESISTANCES OF VARIOUS PLASTICS

+ = resistant o = partly resistant - = not resistant

Medium	Conc.(%)	Temp(°C)	PA66	PA12	POM	PP	TPU	Tefzel®
Acetaldehyde, liquid	100	23	+		+	o	-	+
Acetone	100	23	+	+	+	+	-	+
Ally chloride	100	23				+	-	
Formic acid	98	23	-	-	+	+	-	+
Aniline	100	23	+	o	o	+	-	+
Aromatic compounds					+	-		+
Benzaldehyde	any	23	+		+	+	-	+
Benzine/benzol mix		23	+	+	+	o	o	+
Benzol	100	23	+	+	+	o	-	+
Bromine		23				-	-	
Chlorine, gaseous	100	23				-	o	
Chlorine, liquefied	100	23				-		
Chlorobenzene	100	23				+		
Chloroform	100	23				o		
Chromic acid	10	20	o		+	+		+
Chromic acid	20	23	-		-	+		+
Chromic acid	50	20	-		-	+		+
CFC						o		
Cyclohexane	100	23	+		+	+	+	+
Cyclohexanone	100	23	+		+	+		+
Decahydronaphthalene	100	23	+		+	o		+
Diethyl ether	100	23	+		+	o		+
Di-isopropyl ether	100	23				o		
Dimethyl formamide	100	23	+		+	+		+
Diocyl phthalate(DOP)		23	+		+	+	-	+
Ethanoic acid	10	20	+	o	+	+		+
Ethanoic acid	25	20	+		o	+		+
Ethanoic acid	50	20	+		o	+		+
Ethanoic acid	100	23	o		o	+		+
Ethyl acetate	tech. pure	23		+		o		
Freon		23				+		
Heptane	100	23	+	+	+	+		+
Potass. permanganate	<=6	23	-	-	+	+		+
Ketone				+		+	+	+
Methyl ethyl ketone	100	23	+		o	+	-	+
Methyl Isobutyl Ketone(MIBK)	100	23	+		+	+		+
Engine oil		23		+		+		

Medium	Conc.(%)	Temp(°C)	PA66	PA12	POM	PP	TPU	Tefzel®
Nitrobenzene	100	23	+		+	+	-	+
Ordinary petrol		23				+		
Paraffin oil		23	+	+	+	+		+
Perchlorethylene		23	+	+	+	o	-	+
Petroleum		23	+	+	+	+		+
Phenol	approx. 70		-	-	o	+	-	+
Nitric acid	10	23	-	-	-	+	-	+
Nitric acid	50	20	-	-	-	-	-	+
Carbon bisulphide	100	23	+	+	+	-	-	+
Sulphuric acid	10	20	o	o	+	+	+	+
Sulphuric acid	50	20	-		-	+	+	+
Sulphuric acid	96	23	-		-	-	+	+
Silicon oil		23	+	+	+	+	+	+
Salad oil		23				+		
Carbon tetrachloride	100	23	+	o	+	o	-	+
Toluol	100	23	-	+	+	o	-	+
Trichlorethylene	100	23	+	o	+	o	-	+
Water, cold						+		
Water, hot						+		
Hydrogen peroxide	10	20	-		+	+		+
Hydrogen peroxide	30	23	-		+	+	+	+
Xylene	100	23	+	+	+	o	-	+

* These values are only rough guides. They should be regarded as a material specification and are no substitute for a suitability test. Please see our technical datasheets for further details.

** Tefzel® is a registered trademark of E.T. du Pont de Nemours and Company.

RoHS as the EU's regulation on restricting substances control

Due to the explosive demand and shortening life cycle of consumer electronic goods, the issues on properly disposing the electronic wastes with hazardous substances become the major challenges for all humankind. Dispose all wastes into landfills and incinerators along can not prevent hazardous substances from contaminating the environment. In response to the threat caused by Electrical wastes, EU had established (Directive on the Waste Electronics and Electrical Equipment, WEEE) and "Electrical and Electronic Equipment Directive restricted hazardous substances (RoHS)" standards.

Effective from July 2006, these two standards restricted or prohibited the applications of six major hazardous substances on all electronic, information and communication devices. Products that can not meet the provisions will be restrict by the import ban.

Since July 2006, all Electronic products sold in the European territory must comply with the provisions of the EU's RoHS directive, other countries, such as the United States, Japan and China also have to follow the development of green-related laws.

RoHS Standard regulates the electric devices that operate in voltages under 1,000V AC or 1,500V DC. The following are how they are further categorized:

- Large household appliances
- Small appliances
- Information technology and telecommunication equipments
- Consumer durable equipment
- Lighting, illumination equipments
- Electrical and electronic tools
- Toys, leisure and sports equipment
- Medical devices
- Surveillance, control equipment
- Vending machines

Products within the above categories are not permitted to use the following six hazardous substances:

- Cadmium (Cd): concentration less than <100ppm
- Lead (Pb): concentration less than <1000ppm
- Mercury (Hg): concentration less than <1000ppm
- Hexavalent chromium (Cr6 +): concentration less than <1000ppm
- Polybrominated biphenyl (PBB): concentration less than <1000ppm
- Polybrominated biphenyl ethers (PBDE): concentration less than <1000ppm

The last two substances are usually used as flame retardants. Lead are used to bonding chips and boards, but now are replaced by compounds made of tin, silver, and copper.



REACH – A Program designed by EU to keep record of substance registration, evaluation, authorization and restrictions.

REACH (Registration, Evaluation, Authorization, and Restriction of Chemicals), is a standard that set to promote better health for human beings and the environment protection. It focuses on the prevention of chemical pollution.

REACH replaces 40 existing EU chemicals-related directives and regulations. Started from June 1, 2007, REACH had begun to enforce registration, evaluation, authorization, and implementation of safety monitoring on all chemical products trading in and out of Europe market.

REACH involved with wide range of legislation and guidelines. It stated in REACH's regulation, the chemicals in use will not and should not be the cause of releasing harmful substances from the original forms nor finished products.

The product categories fall under REACH's regulations including electrical unions, electronic devices, home appliances, textiles, clothing, shoes, toys, motor vehicles, and pharmaceutical products. More than 30,000 types of chemical substances are under REACH regulation. Of which, about 1,000 types of harmful substances are listed as toxic. Therefore, the products affected by REACH are estimated up to 500 million. According to the schedule, these 30,000 types of chemical substances will go through the process of registration, evaluation, authorization and restriction procedures by June 1, 2018.

Low Smoke, Halogen Free Product Specifications

After The European Union announced the RoHS directive, U.S., Japan, China and other countries have announced similar policies to promote Green process. In addition to the regulatory frameworks issued by these countries, Greenpeace further requested the manufacturers not to apply polyvinyl chloride (PVC) and brominated flame retardants (BFRs) in their electronic products completely. The products that comply with this standard are qualified as the environmentally safe electric products that are both lead-free and halogen-free.

Halogen, refers to fluorine (F), chlorine (Cl), bromine (Br), iodine (I), Astatine (At) and other non-metallic elements in the periodic table of chemistry. Many industrial raw materials and manufacturing process will be applied with halides, such as PVC, hydrochloric acid etc... However, some types of halides are the cause of pollution that damaged the ecology. Substances under the halide category are for example the ozone depletion substances CFC, Some examples of the well known substance under the halide category is the ozone depletion substances CFC, polybrominated biphenyl (PBB), polybrominated diphenyl ethers (PBDE), and the well known dioxin.

2008 Act of Norway PoHS standards has listed the brominated flame retardant as a banned substances. International organizations, such as IEC, IPC, and JPCA has also defined their specifications on halogen-free materials. Major brand names of electronic and appliances made their commitments on developing halogen-free products progressively in order to comply with the trend of green electronics.

Some specific industries, such as subway, rapid transit, power plants, chemical plants, high-floor buildings, shopping malls, theaters, fire-fighting equipment etc, carry high responsibility on public safety. Therefore, the components used in those industries are usually complied with the most stringent guidelines of low smoke, halogen-free and flame retardant standards.



THE MAIN LOCKING TECHNOLOGIES USED FOR CABLE TIES

Hua Wei offers a wide range of cable ties for use in different applications. By constantly refining our products and satisfying the ever-changing demands of the market, various locking technologies have been developed. Below you will find a brief overview of most common locking technologies and their characteristics.

The Locking Mechanism of Cable Ties

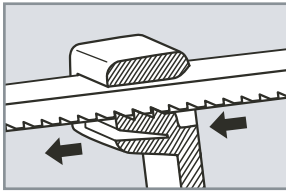

This technology is used in 90% of all polyamide (PA) cable ties applied by Hua Wei. In order to cover a variety of applications, there are different variants of this system, for example: releasable versions and in-line versions.

These are one-piece cable ties, that the pawl is moulded as an integral part of the cable tie, thereby building in inherent strengths.

Locking technology

Positive locking is achieved by engaging the pawl with the strap serrations. This allows the cable tie to perform to the published minimum tensile strength, that is the loading that the cable tie can hold under application.

The Locking Mechanism of Ball Lock Type Stainless Steel Cable Ties

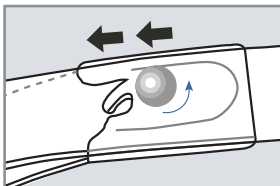

Made of stainless steel grades 304 or 316, the MLG range of cable ties have no serrations on the strap and are threaded parallel through the head, gliding under a metal ball-bearing locking mechanism. By using the GIT-705 application tool the cable tie is tensioned and the strap cut to a flush finish.

Locking technology

The strap is locked into the head by means of the small ball-bearing. The ball locks into the small end of the wedged shaped housing, forming a positive locking with the strap.

This cable tie is not suitable for rigid objects. Retraction of the ball-bearing (see drawing) is required into the small end of the wedged shaped housing to allow for a positive locking of the strap and also to make a flush cut of the end of the strap. Retraction, therefore, cannot take place with the bundling of inflexible materials.

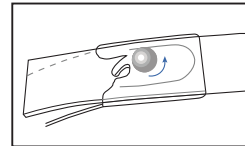

Insert the tail into the buckle. Before the tie is tightened, the internal locking ball still rolls freely.

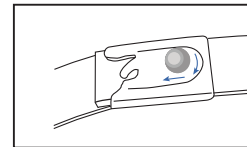

Once the proper tension is reached, use crimping tool to cut off the tail. The ball then wedges into the buckle, locking it tightly against both the top and bottom of the band.

Determination of Minimum Tensile Strength

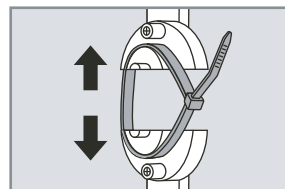

The minimum tensile strength is a critical selection criteria for cable ties. It expresses how much loading a cable tie can bear. This minimum tensile strength is determined in accordance with the Military Specification and Standards of the USA. Test conditions being laid down precisely in MIL-S-23190E:

- Conditioning of the test pieces
- Construction of the test apparatus
- Application of the tie on a split test probe
- Test speed

The test procedure to determine minimum tensile strength

- The cable tie is fixed onto a split mandrel test probe with the suitable cable tie application tool.

- The mandrel is opened at a defined speed.
- The loading at which the cable tie fails is determined. This value is stated in Newtons (N) and is recorded through a computer programme reading the tests.

Explanation of minimum tensile strengths

What does a minimum tensile strength of 225 N (50LBS) mean?

To explain what this value means, the with which the tie can be loaded is calculated. The unit of measurement of the mass is stated in kg. To do so, the unit Newton (N) is shown in the following way: $[N] = [kg \cdot m/s^2]$

The formula for calculating the mass is:

$$\text{Mass} = \frac{\text{minimum tensile strength}}{\text{acceleration due to gravity}}$$

The acceleration due to gravity is 9.81 m/s^2 :

$$\text{Mass} = \frac{\text{minimum tensile strength}}{[kg \cdot m/s^2] / 9.81 [m/s^2]}$$

At a minimum tensile strength of 225 N(50LBS) the mass is:

$$\text{Mass} = 225 [kg \cdot m/s^2] / 9.81 [m/s^2]$$

The units m/s^2 cancel each other out, leaving the unit [kg] for the mass. Thus:

$$\text{Mass} = 225/9.81 \text{ kg} = 22.2 \text{ kg}$$

Therefore, a cable tie with a minimum tensile strength of 225 N (50LBS) can be loaded with 22.2 kg. Conversely, with the required loading capacity the minimum tensile strength can be calculated by a mass:

$$\text{Min. tensile strength} = \text{mass} \cdot 9.81 [m/s^2]$$

If the tie is to be loaded with, for example, 53 kg this produces:

$$\begin{aligned} \text{Minimum tensile strength} \\ = [53 \text{ kg}] \cdot 9.81 [m/s^2] = 520 \text{ N} \end{aligned}$$

In order to withstand a load of 53 kg, the tie must therefore have a minimum tensile strength of 520 N. In this case, select our product with a minimum tensile strength of 535 N (120LBS).

Optimum Storage Conditions for Cable Ties Made of Polyamide (PA)

Hua Wei cable ties, fastenings and fixings are manufactured from high-quality polyamide (PA). This industrial synthetic material is mainly processed using injection moulding, but can also be extruded.

Polyamide is a hygroscopic material. This means that the material absorbs and loses moisture. For optimum handling of cable ties it is important that the material is in a condition of equilibrium with a water content of approximately 2.5%.

The packaging used by Hua Wei ensures that the water content in the material remains constant. Therefore, it is important to store the products in their original packaging to preserve the quality of the ties.



Always store ties in the sealed plastic bag made of polyethylene. Once opened you should use the ties as quick as possible.

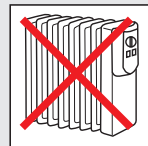

Store the product away from direct sources of heat. Avoid contact with heat: for example, do not place on the radiators.



Do not store the product in sunlight; for example, on the windowsill.

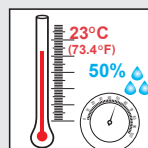

The ideal storage conditions are those of the central European standard climate: 23°C (73.4°F), 50% relative humidity.

MATERIAL & APPLICATION TABLE

Fastening System
Cable Ties

Hua Wei's cable ties made by Polyamide 6,6 could be heat stabilized, weather resistant or flame retardant by customers' order. Please contact our sales for reference.

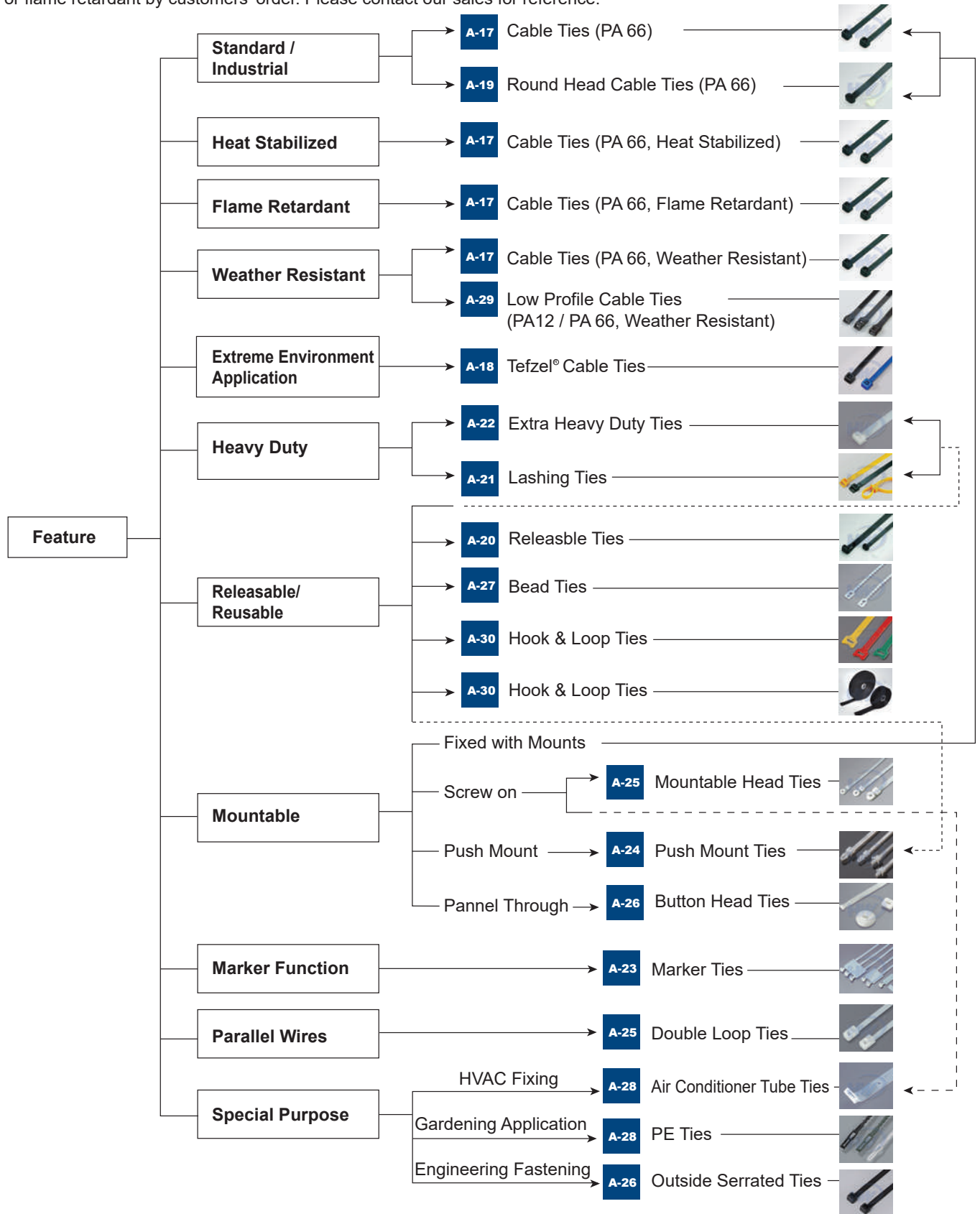

Hua Wei provides a full line of high quality cable ties in a wide range of sizes, materials, colors and styles for fastening, bundling, securing and identifying in a variety of application.

All Hua Wei's cable ties are engineered and manufactured to meet or exceed industry standards to guarantee maximum reliability. Hua Wei also provides a full range of cable tie installation tools to ensure safe and speed operations.

Tefzel® is a registered trademark of E.T. du Pont de Nemours and Company.

Product Name	Cable Ties				Tefzel® Cable Ties
Type	GT				GT-TF
Page	A-17				A-18
Material	Polyamide 6,6	Polyamide 6,6 Heat Stabilized	Polyamide 6,6 Flame Retardant	Polyamide 6,6 Weather Resistant	Tefzel®
Operating Temperature					
Max.	85°C (185°F)	120°C (248°F)	85°C (185°F)	85°C (185°F)	170°C (338°F)
Min.	-40°C (-40°F)	-40°C (-40°F)	-40°C (-40°F)	-40°C (-40°F)	-60°C (-76°F)
Resistant Properties					
UV light/ozone	△	△	△	◎	◎
Oils and greases	◎	◎	◎	◎	◎
Solvents	○	○	○	○	◎
Petrol	◎	◎	◎	◎	◎
Flammability	UL94V-2	UL94V-2	UL94V-0	UL94V-2	UL94V-0
Possible Applications					
Switch cabinets	★	★	★	★	★
Electronics	★	★	★	★	★
Aerospace industries	★	★	★	★	★
Turbines and engines		★			★
Telecommunications	★	★	★	★	★
Ship-building/Marine	★	★	★	★	★
Military industry	★	★	★	★	★
Harnessmakers	★	★	★	★	★
Public buildings	★	★	★	★	★
Automotives industries	★	★	★	★	★
Sample Applications					
Bundling of cables and wires	★	★	★	★	★
Bundling of hoses	★	★	★	★	★
Welded or threaded studs					
Drilled hole with thread					
Edge fastening on steel plated					
Blind holes in sheet metal					
Fixing with self adhesive base	★	★	★	★	★
Bundling of optical cables	☆	☆	☆	☆	★
Fastening optical cables	☆	☆	☆	☆	★
For restricted space					
Fastening bellows					
Parallel wires					
Post-installation fastening					
Temporary fastening	☆	☆	☆	☆	★
For thin, sensitive insulation					
Underwater use					★
Identification of bundles					

◎ Excellent ○ Good △ Medium ★ Suitable ☆ Partly Suitable

Tefzel® is a registered trademark of E.T. du Pont de Nemours and Company.

MATERIAL & APPLICATION TABLE

**Fastening System
Cable Ties**

Product Name	Round Head Cable Ties	Releasable Ties	Lashing Ties	Extra Heavy Duty Ties
Type	GTE	GTR, GTRN	GT-LT	GT-EHD
Page	A-19	A-20	A-21	A-22
Material	Polyamide 6,6	Polyamide 6,6	Polyamide 6,6	Polyamide 6,6
Operating Temperature				
Max.	85°C (185°F)	85°C (185°F)	85°C (185°F)	85°C (185°F)
Min.	-40°C (-40°F)	-40°C (-40°F)	-40°C (-40°F)	-40°C (-40°F)
Resistant Properties				
UV light/ozone	△	△	△	△
Oils and greases	◎	◎	◎	◎
Solvents	○	○	○	○
Petrol	◎	◎	◎	◎
Flammability	UL94V-2	UL94V-2	UL94V-2	UL94V-2
Possible Applications				
Switch cabinets	★	★	★	★
Electronics	★	★	★	★
Aerospace industries	★	★	★	★
Turbines and engines				
Telecommunications	★	★	★	★
Ship-building/Marine	★	★	★	★
Military industry	★	★	★	★
Harnessmakers	★	★	★	★
Public buildings	★	★	★	★
Automotives industries	★	★	★	★
Sample Applications				
Bundling of cables and wires	★	★	★	★
Bundling of hoses	★	★	★	★
Welded or threaded studs				
Drilled hole with thread				
Edge fastening on steel plated				
Blind holes in sheet metal				
Fixing with self adhesive base	★	★		
Bundling of optical cables	☆		☆	☆
Fastening optical cables	☆		☆	☆
For restricted space				
Fastening bellows				
Parallel wires				
Post-installation fastening				★
Temporary fastening	☆	★	★	★
For thin, sensitive insulation				
Underwater use				
Identification of bundles				

◎ Excellent ○ Good △ Medium ★ Suitable ☆ Partly Suitable

Product Name	Marker Ties	Push Mount Ties	Double Loop Ties	Mountable Head Ties
Type	GTK	GTP, GTRP	GTB	GTM
Page	A-23	A-24	A-25	A-25
Material	Polyamide 6,6	Polyamide 6,6	Polyamide 6,6	Polyamide 6,6
Operating Temperature				
Max.	85°C (185°F)	85°C (185°F)	85°C (185°F)	85°C (185°F)
Min.	-40°C (-40°F)	-40°C (-40°F)	-40°C (-40°F)	-40°C (-40°F)
Resistant Properties				
UV light/ozone	△	△	△	△
Oils and greases	◎	◎	◎	◎
Solvents	○	○	○	○
Petrol	◎	◎	◎	◎
Flammability	UL94V-2	UL94V-2	UL94V-2	UL94V-2
Possible Applications				
Switch cabinets	★	★	★	★
Electronics	★	★	★	★
Aerospace industries	★	★	★	★
Turbines and engines				
Telecommunications	★		★	
Ship-building/Marine	★	★	★	★
Military industry	★		★	
Harnessmakers	★	★	★	★
Public buildings			★	
Automotives industries		★	★	★
Sample Applications				
Bundling of cables and wires	★	★	★	★
Bundling of hoses		★	★	★
Welded or threaded studs				★
Drilled hole with thread		★		★
Edge fastening on steel plated				
Blind holes in sheet metal				
Fixing with self adhesive base				
Bundling of optical cables	★			
Fastening optical cables	★			
For restricted space	★			
Fastening bellows				
Parallel wires			★	
Post-installation fastening		★		★
Temporary fastening		★		
For thin, sensitive insulation				
Underwater use				
Identification of bundles	★			

◎ Excellent ○ Good △ Medium ★ Suitable ☆ Partly Suitable

MATERIAL & APPLICATION TABLE

**Fastening System
Cable Ties**

Product Name	Button Head Ties	Outside Serrated Ties	Bead Ties	Stop Ties
Type	GTA	GTPG	GTB	GT-MA, GT-IA
Page	A-26	A-26	A-27	A-27
Material	Polyamide 6,6	Polyamide 6,6	Polyamide 6,6	Polyamide 6,6
Operating Temperature				
Max.	85°C (185°F)	85°C (185°F)	85°C (185°F)	85° (185°F)
Min.	-40°C (-40°F)	-40°C (-40°F)	-40°C (-40°F)	-40° (-40°F)
Resistant Properties				
UV light/ozone	△	△	△	△
Oils and greases	◎	◎	◎	◎
Solvents	○	○	○	○
Petrol	◎	◎	◎	◎
Flammability	UL94V-2	UL94V-2	UL94V-2	UL94V-2
Possible Applications				
Switch cabinets	★	★	★	
Electronics		★	★	
Aerospace industries	★	★		
Turbines and engines		★		
Telecommunications		★	★	
Ship-building/Marine	★	★		
Military industry		★		
Harnessmakers	★	★	★	
Public buildings		★	★	
Automotives industries	★	★	★	
Sample Applications				
Bundling of cables and wires	★	★	★	
Bundling of hoses	★	★	★	
Welded or threaded studs				
Drilled hole with thread	★			
Edge fastening on steel plated				
Blind holes in sheet metal				
Fixing with self adhesive base				
Bundling of optical cables		★		
Fastening optical cables				
For restricted space		★		
Fastening bellows				
Parallel wires				
Post-installation fastening			★	
Temporary fastening			★	★
For thin, sensitive insulation		★		
Underwater use				
Identification of bundles				★

◎ Excellent ○ Good △ Medium ★ Suitable ☆ Partly Suitable

Product Name	PE Ties	Air Conditioner Tube Ties	Low Profile Cable Ties		Hook & Loop Cable Ties
Type	AST	BT	GTN / GTNL		VL
Page	A-28	A-28	A-29		A-30
Material	PE	PE	Polyamide 12	Polyamide 6,6 Weather Resistant	Polyamide / PP
Operating Temperature					
Max.	80°C (176°F)	80°C (176°F)	95°C (203°F)	85°C (185°F)	75°C (166°F)
Min.	-40°C (-40°F)	-40°C (-40°F)	-40°C ^a (-40°F)	-40°C (-40°F)	-20°C (-4°F)
Resistant Properties					
UV light/ozone	△	△	○	◎	○
Oils and greases	△	△	○	◎	○
Solvents	△	△	△	○	△
Petrol	△	△	○	◎	○
Flammability	--	--	UL94HB	UL94V-2	UL94HB
Possible Applications					
Switch cabinets				★	★
Electronics	★			★	★
Aerospace industries				★	
Turbines and engines				☆	
Telecommunications				★	★
Ship-building/Marine				★	
Military industry				★	
Harnessmakers	★			★	★
Public buildings		★		★	☆
Automotives industries				★	☆
Sample Applications					
Bundling of cables and wires				★	★
Bundling of hoses	★	★		★	★
Welded or threaded studs		☆			
Drilled hole with thread		★			
Edge fastening on steel plated					
Blind holes in sheet metal					
Fixing with self adhesive base					
Bundling of optical cables				★	★
Fastening optical cables					
For restricted space		★		★	★
Fastening bellows					
Parallel wires					
Post-installation fastening					★
Temporary fastening	★				
For thin, sensitive insulation				★	★
Underwater use					
Identification of bundles					☆

◎ Excellent ○ Good △ Medium ★ Suitable ☆ Partly Suitable

CABLE TIE ORDERING SPECIFICATION

GT – **100** **M** **B** **V0**
1 **2** **3** **4** **5**

- 1** Type
- 2** Length
- 3** Width —————• M=Miniature, I=Intermediate, ST=Standard, HD=Heavy Duty, EHD=Extra Heavy Duty
- 4** Color —————• No Suffix=Natural, B=Black, RD=Red, OR=Orange, YL=Yellow, GN=Green, BL=Blue
- 5** Material —————• UV=Ultraviolet weather resistant tie for outdoor application, H=Heat stabilized, V0=Flame retardant



MATERIAL DESCRIPTIONS

Material	Operating Temperature		UL94 Flammability Rating	UV Resistance
	Max.	Min.		
Polyamide 6,6 (PA 66)	85°C 185°F	-40°C -40°F	UL94V-2	Normal
Polyamide 6,6 (PA 66) Weather Resistant	85°C 185°F	-40°C -40°F	UL94V-2	Good
Polyamide 6,6 (PA 66) Heat Stabilized	120°C 248°F	-40°C -40°F	UL94V-2	Normal
Polyamide 6,6 (PA 66) Flame Retardant	85°C 185°F	-40°C -40°F	UL94V-0	Normal
Polyamide 12 (PA 12)	95°C 203°F	-40°C -40°F	UL94HB	Excellent
Tefzel® (ETFE)	170°C 338°F	-60°C -76°F	UL94V-0	Excellent
Polyethylene (PE)	80°C 176°F	-40°C -40°F	--	Normal

*Tefzel® is a registered trademark of E.T. du Pont de Nemours and Company.

CABLE TIES

- Available in a wide range of materials
- Internal serrations allowing for a positive hold onto cable and pipe bundles
- The design of the head guarantees a high tensile strength while allowing a very low insertion force
- Flame retardant, heat stabilized weather resistant are available
- Material: Polyamide 6,6, UL94V-2
- Color: All colors are available

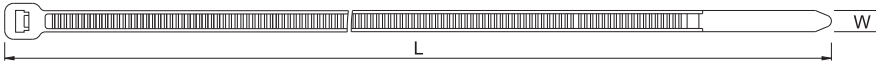

Part No.	Length (L) mm (inch)	Width (W) mm (inch)	Max.Bundle ø mm (inch)	Min. Loop Tensile Strength			Recommended Tensioning Tools
				N	kgf	lbf	
GT-80M	80 (3.15)	2.4 (0.09)	15 (0.59)	80	8.2	18	 GIT-701
GT-100M	100 (3.94)	2.5 (0.10)	22 (0.87)	80	8.2	18	
GT-120M	120 (4.72)	2.5 (0.10)	30 (1.18)	80	8.2	18	
GT-140M	140 (5.51)	2.5 (0.10)	33 (1.30)	80	8.2	18	
GT-160M	160 (6.30)	2.5 (0.10)	40 (1.57)	80	8.2	18	
GT-200M	200 (7.87)	2.5 (0.10)	53 (2.09)	80	8.2	18	
GT-140I	140 (5.51)	3.6 (0.14)	33 (1.30)	178	18.2	40	 GIT-702P
GT-200I	200 (7.87)	3.6 (0.14)	53 (2.09)	178	18.2	40	
GT-250I	250 (9.84)	3.6 (0.14)	65 (2.56)	178	18.2	40	
GT-300I	300 (11.81)	3.6 (0.14)	76 (2.99)	178	18.2	40	
GT-370I	370 (14.57)	3.6 (0.14)	102 (4.02)	178	18.2	40	
GT-160ST	160 (6.30)	4.8 (0.19)	38 (1.50)	222	22.6	50	 GIT-702M
GT-190ST	190 (7.48)	4.8 (0.19)	46 (1.81)	222	22.6	50	
GT-200ST	200 (7.87)	4.8 (0.19)	50 (1.97)	222	22.6	50	
GT-250ST	250 (9.84)	4.8 (0.19)	60 (2.36)	222	22.6	50	
GT-300ST	300 (11.81)	4.8 (0.19)	76 (2.99)	222	22.6	50	
GT-370ST	370 (14.57)	4.8 (0.19)	102 (4.02)	222	22.6	50	
GT-430ST	430 (16.93)	4.8 (0.19)	110 (4.33)	222	22.6	50	
GT-530ST	530 (20.87)	4.8 (0.19)	140 (5.51)	222	22.6	50	 GIT-703
GT-200HD	200 (7.87)	7.6 (0.30)	50 (1.97)	534	54.5	120	
GT-300HD	300 (11.81)	7.6 (0.30)	76 (2.99)	534	54.5	120	 GIT-704G
GT-370HD	370 (14.57)	7.6 (0.30)	102 (4.02)	534	54.5	120	
GT-430HD-S	430 (16.93)	7.6 (0.30)	123 (4.84)	534	54.5	120	
GT-540HD-S	533 (20.98)	7.6 (0.30)	140 (5.51)	534	54.5	120	
GT-430HD	430 (16.93)	9.0 (0.35)	120 (4.72)	778	79.3	175	
GT-530HD	530 (20.87)	9.0 (0.35)	140 (5.51)	778	79.3	175	
GT-630HD	609 (23.98)	9.0 (0.35)	187 (7.36)	778	79.3	175	
GT-780HD	778 (30.63)	9.0 (0.35)	228 (8.99)	778	79.3	175	
GT-830HD	815 (32.09)	9.0 (0.35)	239 (9.42)	778	79.3	175	
GT-920HD	916 (36.06)	9.0 (0.35)	263 (10.35)	778	79.3	175	
GT-1220HD	1220 (48.03)	9.0 (0.35)	365 (14.37)	778	79.3	175	
GT-1530HD	1530 (60.24)	9.0 (0.35)	460 (18.11)	778	79.3	175	 GIT-709

* Other sizes available. Subject to minimum order request.

TEFZEL® CABLE TIES

- Tefzel® cable ties are specialized cable ties recommended for applications requiring high resistance to environmental stresses such as chemical attack, gamma radiation, ultraviolet radiation, and extreme temperatures.
- Ideal for use in nuclear power facilities and chemical processing plants
- Standard color of Tefzel® cable tie is blue
- Material: Tefzel® (ETFE)
- Color: Blue, black

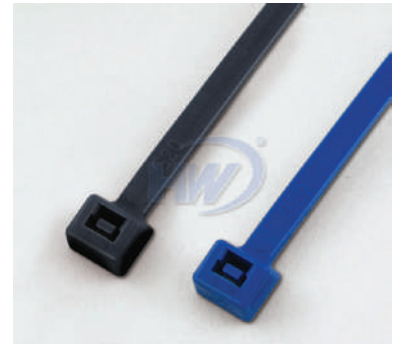

Part No.	Length (L) mm (inch)	Width (W) mm (inch)	Max. Bundle ø mm (inch)	Min. Loop Tensile Strength		
				N	kgf	lbf
GT-100M-TF	102 (4.02)	2.4 (0.09)	22 (0.87)	80	8.2	18
GT-150I-TF	150 (5.91)	3.6 (0.14)	35 (1.38)	178	18.2	40
GT-200I-TF	200 (7.87)	3.6 (0.14)	53 (2.09)	178	18.2	40
GT-190ST-TF	190 (7.48)	4.6 (0.18)	46 (1.81)	222	22.6	50
GT-200ST-TF	200 (7.87)	4.6 (0.18)	50 (1.97)	222	22.6	50
GT-300ST-TF	300 (11.81)	4.8 (0.19)	76 (2.99)	222	22.6	50
GT-370ST-TF	370 (14.57)	4.6 (0.18)	102 (4.02)	222	22.6	50
GT-300HD-TF	300 (11.81)	7.3 (0.29)	76 (2.99)	445	45.4	100
GT-370HD-TF	370 (14.57)	7.4 (0.29)	102 (4.02)	445	45.4	100
GT-430HD-TF	435 (17.13)	8.8 (0.35)	125 (4.92)	445	45.4	100

*Tefzel® is a registered trademark of E.T. du Pont de Nemours and Company.

ROUND HEAD TIES

- Available in a wide range of materials
- Internal serrations allowing for a positive hold onto cable and pipe bundles
- The design of the head guarantees a high tensile strength while allowing a very low insertion force
- Material: Polyamide 6,6, UL94V-2
- Color: All colors are available

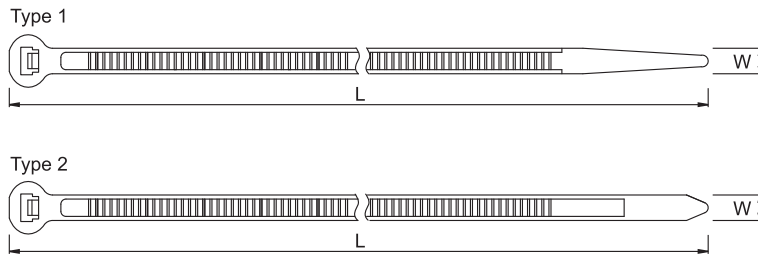

Part No.	Type	Length (L) mm (inch)	Width (W) mm (inch)	Max.Bundle ϕ mm (inch)	Min. Loop Tensile Strength		
					N	kgf	lbf
GTE-100M	1	100 (3.94)	2.5 (0.10)	22 (0.87)	97	9.9	22
GTE-160M	1	160 (6.30)	2.5 (0.10)	40 (1.57)	97	9.9	22
GTE-200M	1	200 (7.87)	2.5 (0.10)	53 (2.09)	97	9.9	22
GTE-140I	1	140 (5.51)	3.6 (0.14)	33 (1.30)	213	21.7	48
GTE-200I	1	200 (7.87)	3.6 (0.14)	53 (2.09)	213	21.7	48
GTE-300I	1	300 (11.81)	3.6 (0.14)	76 (2.99)	213	21.7	48
GTE-370I	1	370 (14.57)	3.6 (0.14)	102 (4.02)	213	21.7	48
GTE-120ST	1	120 (4.72)	4.8 (0.19)	24 (0.94)	254	25.9	57
GTE-160ST	1	160 (6.30)	4.8 (0.19)	38 (1.50)	254	25.9	57
GTE-190ST	1	188 (7.40)	4.8 (0.19)	46 (1.81)	254	25.9	57
GTE-280ST	1	280 (11.02)	4.8 (0.19)	70 (2.76)	254	25.9	57
GTE-300ST	1	300 (11.81)	4.8 (0.19)	76 (2.99)	254	25.9	57
GTE-370ST	1	370 (14.57)	4.8 (0.19)	102 (4.02)	254	25.9	57
GTE-200HD	2	200 (7.87)	7.6 (0.30)	50 (1.97)	636	64.9	143
GTE-250HD	2	250 (9.84)	7.6 (0.30)	65 (2.56)	636	64.9	143
GTE-300HD	2	300 (11.81)	7.6 (0.30)	76 (2.99)	636	64.9	143
GTE-370HD	2	370 (16.93)	7.6 (0.30)	102 (4.02)	636	64.9	143
GTE-430HD	2	430 (16.93)	7.6 (0.30)	110 (4.33)	636	64.9	143
GTE-450HD	2	450 (17.72)	7.6 (0.30)	132 (5.20)	636	64.9	143
GTE-530HD	2	530 (20.87)	7.6 (0.30)	140 (5.51)	636	64.9	143

RELEASABLE TIES

Fastening System
Cable Ties

- The extended pawl allows for simple and quick release of the ties
- One-piece construction for consistent performance and reliability
- Permits easy release and re-use where changes are anticipated during development, production or servicing in the field
- Material: Polyamide 6,6, UL94V-2
- Color: All colors are available

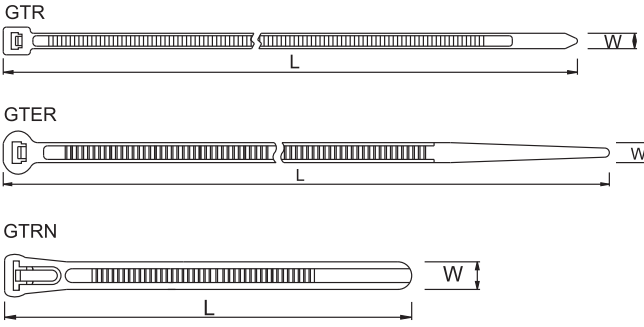

Part No.	Length (L) mm (inch)	Width (W) mm (inch)	Max. Bundle ϕ mm (inch)	Min. Loop Tensile Strength		
				N	kgf	lbf
GTR-140I	140 (5.51)	3.6 (0.14)	33 (1.30)	178	18.2	40
GTR-200ST	200 (7.87)	4.8 (0.19)	50 (1.97)	222	22.6	50
GTR-300ST	300 (11.81)	4.8 (0.19)	76 (2.99)	222	22.6	50
GTR-370ST	370 (14.57)	4.8 (0.19)	102 (4.02)	222	22.6	50
GTR-430ST	430 (16.93)	4.8 (0.19)	110 (4.33)	222	22.6	50
GTR-530ST	530 (20.87)	4.8 (0.19)	140 (5.51)	222	22.6	50
GTR-450HD	450 (17.72)	9.0 (0.35)	132 (5.20)	778	79.3	175
GTR-530HD	530 (20.87)	9.0 (0.35)	140 (5.51)	778	79.3	175
GTR-630HD	624 (24.57)	9.0 (0.35)	178 (7.01)	778	79.3	175
GTR-920HD	920 (36.22)	9.0 (0.35)	263 (10.35)	778	79.3	175
GTRN-100HD	100 (3.94)	7.6 (0.30)	20 (0.79)	222	22.6	50
GTRN-120HD	120 (4.72)	7.6 (0.30)	30 (1.18)	222	22.6	50
GTRN-150HD	150 (5.91)	7.6 (0.30)	35 (1.38)	222	22.6	50
GTRN-200HD	200 (7.87)	7.6 (0.30)	50 (1.97)	222	22.6	50
GTRN-250HD	250 (9.84)	7.6 (0.30)	66 (2.60)	222	22.6	50
GTRN-300HD	300 (11.81)	7.6 (0.30)	80 (3.15)	222	22.6	50
GTRN-370HD	370 (14.57)	7.6 (0.30)	102 (4.02)	222	22.6	50
Round Head						
GTER-370ST	370 (14.57)	4.8 (0.19)	102 (4.02)	254	26.0	57

LASHING TIES

- After fastening, insert remaining length of the tie into buckle to enhance tensile strength and avoid tie to slip off
- Typically used for heavy duty applications such as securing conduit or large cable bundles to permanent structures
- Material: Polyamide 6,6, UL94V-2
- Color: All colors are available



Fastening System
Cable Ties

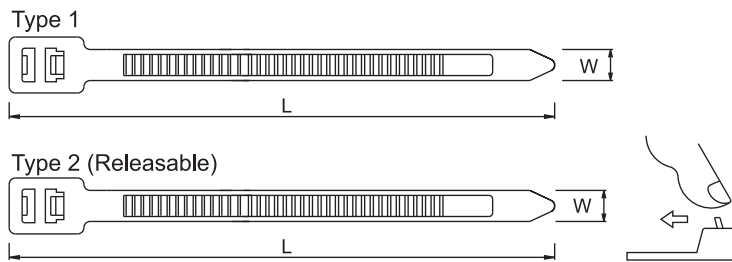

Part No.	Length (L) mm (inch)	Width (W) mm (inch)	Max.Bundle ø mm (inch)	Min. Loop Tensile Strength		
				N	kgf	lbf
GT-240LT	235 (9.25)	12.6 (0.50)	50 (1.97)	1112	113.4	250
GT-300LT	300 (11.81)	12.6 (0.50)	76 (2.99)	1112	113.4	250
GT-390LT	390 (15.35)	12.6 (0.50)	103 (4.05)	1112	113.4	250
GT-415LT	412 (16.22)	12.6 (0.50)	110 (4.33)	1112	113.4	250
GT-490LT	485 (19.09)	12.6 (0.50)	135 (5.31)	1112	113.4	250
GT-590LT	585 (23.03)	12.6 (0.50)	152 (5.98)	1112	113.4	250
GT-740LT	735 (28.94)	12.6 (0.50)	204 (8.03)	1112	113.4	250
GT-890LT	885 (34.84)	12.6 (0.50)	248 (9.76)	1112	113.4	250
GT-1040LT	1035 (40.75)	12.6 (0.50)	295 (11.61)	1112	113.4	250
Releasable						
GTR-240LT	235 (9.25)	12.6 (0.50)	50 (1.97)	1112	113.4	250
GTR-300LT	300 (11.81)	12.6 (0.50)	76 (2.99)	1112	113.4	250
GTR-390LT	390 (15.35)	12.6 (0.50)	103 (4.05)	1112	113.4	250
GTR-415LT	412 (16.22)	12.6 (0.50)	110 (4.33)	1112	113.4	250
GTR-490LT	485 (19.09)	12.6 (0.50)	135 (5.31)	1112	113.4	250
GTR-590LT	585 (23.03)	12.6 (0.50)	152 (5.98)	1112	113.4	250
GTR-740LT	735 (28.94)	12.6 (0.50)	204 (8.03)	1112	113.4	250
GTR-890LT	885 (34.84)	12.6 (0.50)	248 (9.76)	1112	113.4	250
GTR-1040LT	1035 (40.75)	12.6 (0.50)	295 (11.61)	1112	113.4	250

EXTRA HEAVY DUTY TIES

Fastening System
Cable Ties

- Extra heavy duty ties for application where higher tensile strength is required
- One-piece construction for consistent performance and reliability
- Lowest threading force of any one-piece cable tie in the industry
- Material: Polyamide 6,6, UL94V-2
- Color: All colors are available

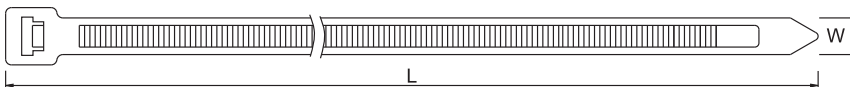
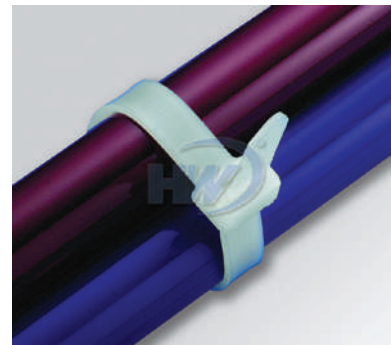

Part No.	Length (L) mm (inch)	Width (W) mm (inch)	Max.Bundle ø mm (inch)	Min. Loop Tensile Strength		
				N	kgf	lbf
GT-230EHD	230 (9.06)	12.6 (0.50)	50 (1.97)	1112	113.4	250
GT-290EHD	295 (11.61)	12.6 (0.50)	76 (2.99)	1112	113.4	250
GT-380EHD	380 (14.96)	12.6 (0.50)	106 (4.17)	1112	113.4	250
GT-480EHD	480 (18.90)	12.6 (0.50)	120 (4.72)	1112	113.4	250
GT-580EHD	580 (22.83)	12.6 (0.50)	152 (5.98)	1112	113.4	250
GT-730EHD	730 (28.74)	12.6 (0.50)	204 (8.03)	1112	113.4	250
GT-880EHD	880 (34.65)	12.6 (0.50)	248 (9.76)	1112	113.4	250
GT-1030EHD	1020 (40.16)	12.6 (0.50)	295 (11.61)	1112	113.4	250
Releasable						
GTR-230EHD	230 (9.06)	12.6 (0.50)	50 (1.97)	1112	113.4	250
GTR-290EHD	295 (11.61)	12.6 (0.50)	76 (2.99)	1112	113.4	250
GTR-380EHD	380 (14.96)	12.6 (0.50)	106 (4.17)	1112	113.4	250
GTR-480EHD	480 (18.90)	12.6 (0.50)	120 (4.72)	1112	113.4	250
GTR-580EHD	580 (22.83)	12.6 (0.50)	152 (5.98)	1112	113.4	250
GTR-730EHD	730 (28.74)	12.6 (0.50)	204 (8.03)	1112	113.4	250
GTR-880EHD	880 (34.65)	12.6 (0.50)	248 (9.76)	1112	113.4	250
GTR-1030EHD	1020 (40.16)	12.6 (0.50)	295 (11.61)	1112	113.4	250

MARKER TIES

- Tie and identify bundles of cable in one operation
- Large flat area for imprinting or writing the required information
- Hot stamping available, which is subject to minimums and lead times
- Label may be imprinted or written with marker pen
- Material: Polyamide 6,6, UL94V-2
- Color: All colors are available

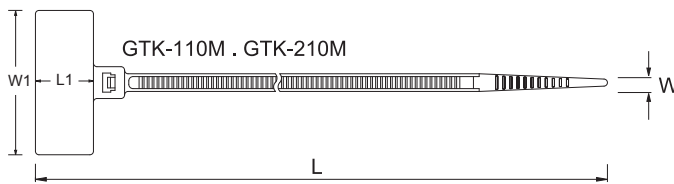

Part No.	Length (L) mm (inch)	Width (W) mm (inch)	Max.Bundle ø mm (inch)	Min. Loop Tensile Strength			Marker Area (L1xW1) mm (inch)
				N	kgf	lbf	
GTK-110M	110 (4.33)	2.5 (0.10)	18 (0.71)	80	8.2	18	9.1x20.4 (0.36x0.80)
GTK-210M	210 (8.27)	2.5 (0.10)	50 (1.97)	80	8.2	18	9.1x20.4 (0.36x0.80)

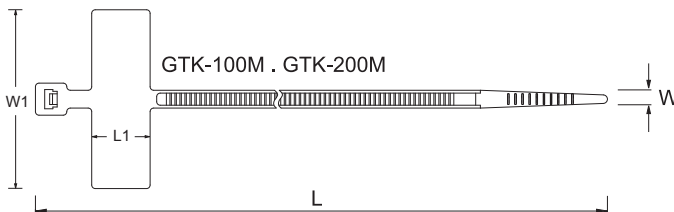

Part No.	Length (L) mm (inch)	Width (W) mm (inch)	Max.Bundle ø mm (inch)	Min. Loop Tensile Strength			Marker Area (L1xW1) mm (inch)
				N	kgf	lbf	
GTK-100M	102 (4.02)	2.5 (0.10)	18 (0.71)	80	8.2	18	8.0x25.4 (0.31x1.00)
GTK-200M	200 (7.87)	2.5 (0.10)	50 (1.97)	80	8.2	18	8.0x25.4 (0.31x1.00)

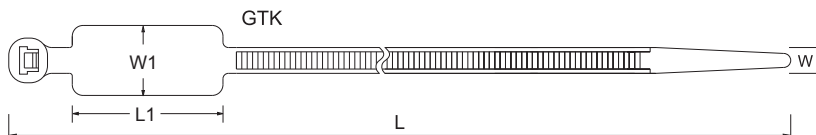

Part No.	Length (L) mm (inch)	Width (W) mm (inch)	Max.Bundle ø mm (inch)	Min. Loop Tensile Strength			Marker Area (L1xW1) mm (inch)
				N	kgf	lbf	
GTK-190ST	190 (7.48)	4.8 (0.19)	46 (1.81)	222	22.6	50	28.0x13.0 (1.10x0.51)
GTK-220ST	220 (8.66)	4.8 (0.19)	54 (2.13)	222	22.6	50	28.0x13.0 (1.10x0.51)
GTK-270ST	270 (10.63)	4.8 (0.19)	65 (2.56)	222	22.6	50	28.0x13.0 (1.10x0.51)
GTK-300ST	300 (11.81)	4.8 (0.19)	76 (2.99)	222	22.6	50	28.0x13.0 (1.10x0.51)
GTK-370ST	370 (14.57)	4.8 (0.19)	102 (4.02)	222	22.6	50	28.0x13.0 (1.10x0.51)

PUSH MOUNT TIES

- The wing design of the mount helps stabilize the tie in high vibration applications
- These ties are ideal for fixing bundles along a wide range of surfaces materials such as sheet metal, wood, or cast iron
- One-piece, all plastic ties for quick, simple cable mounting
- Applying by first drilling a hole on panel or board with appropriate hole diameter and board thickness. Insert the mount head to the hole for fixture
- Material: Polyamide 6,6, UL94V-2
- Color: All colors are available

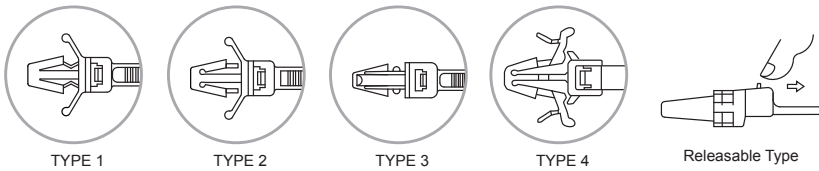
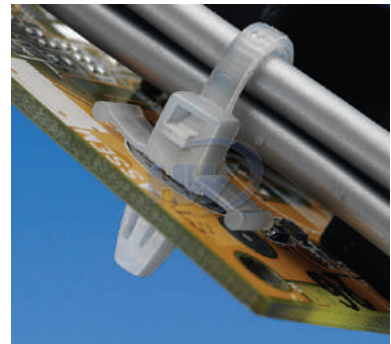
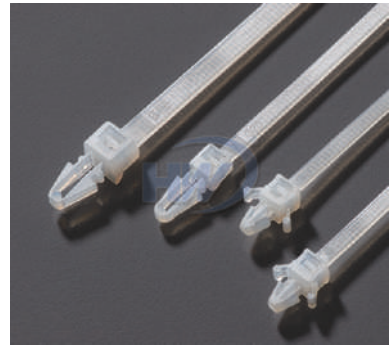

Part No.	Type	Length (L) mm (inch)	Width (W) mm (inch)	Max.Bundle ø mm (inch)	Min. Loop Tensile Strength			Mounting Hole ø mm (inch)	Panel Thickness mm (inch)
					N	kgf	lbf		
GTP-110M	1	110 (4.33)	2.5 (0.10)	22 (0.87)	80	8.2	18	4.8 (0.19)	~2.4 (0.09)
GTP-130M	1	130 (5.12)	2.5 (0.10)	28 (1.10)	80	8.2	18	4.8 (0.19)	~2.4 (0.09)
GTP-130I	1	130 (5.12)	3.2 (0.13)	28 (1.10)	133	13.6	30	4.0 (0.16)	~2.0 (0.08)
GTP-110ST	1	110 (4.33)	4.8 (0.19)	22 (0.87)	222	22.6	50	6.4 (0.25)	~3.2 (0.13)
GTP-130ST	1	130 (5.12)	4.8 (0.19)	25 (0.98)	222	22.6	50	6.4 (0.25)	~3.2 (0.13)
GTP-190ST	1	200 (7.87)	4.8 (0.19)	45 (1.77)	222	22.6	50	6.4 (0.25)	~3.2 (0.13)
GTP-110MA	2	110 (4.33)	2.5 (0.10)	22 (0.87)	80	8.2	18	4.8 (0.19)	~2.4 (0.09)
GTP-130MA	2	130 (5.12)	2.5 (0.10)	28 (1.10)	80	8.2	18	4.8 (0.19)	~2.4 (0.09)
GTP-130IA	2	130 (5.12)	3.2 (0.13)	28 (1.10)	133	13.6	30	4.0 (0.16)	~2.0 (0.08)
GTPS-100ST	2	100 (3.94)	4.8 (0.19)	18 (0.71)	222	22.6	50	6.4 (0.25)	~3.2 (0.13)
GTPS-190ST	2	190 (7.48)	4.8 (0.19)	45 (1.77)	222	22.6	50	6.4 (0.25)	~3.2 (0.13)
GTP-150I	3	150 (5.91)	3.6 (0.14)	32 (1.26)	133	13.6	30	5.2 (0.21)	~2.8 (0.11)
GTP-200ST	3	202 (7.91)	4.8 (0.19)	46 (1.81)	222	22.6	50	6.4 (0.25)	~3.6 (0.14)
Releasable									
GTRP-130I	1	130 (5.12)	3.2 (0.13)	28 (1.10)	133	13.6	30	4.0 (0.16)	~2.0 (0.08)
GTRP-110ST	1	110 (4.33)	4.8 (0.19)	17 (0.67)	222	22.6	50	6.4 (0.25)	~3.2 (0.13)
GTRP-130ST	1	130 (5.12)	4.8 (0.19)	25 (0.98)	222	22.6	50	6.4 (0.25)	~3.2 (0.13)
GTRP-190ST	1	200 (7.78)	4.8 (0.19)	45 (1.77)	222	22.6	50	6.4 (0.25)	~3.2 (0.13)
GTRP-170ST	2	170 (6.73)	4.8 (0.19)	38 (1.50)	222	22.6	50	6.4 (0.25)	~3.2 (0.13)
GTRP-200ST	3	200 (7.78)	4.8 (0.19)	46 (1.81)	222	22.6	50	6.4 (0.25)	~3.6 (0.14)
GTRP-100I	4	100 (3.94)	3.5 (0.14)	22 (0.87)	133	13.6	30	4.0 (0.16)	~2.0 (0.08)

DOUBLE LOOP TIES

- The tie's second loop may also serve as a positioning device for a single bundle
- Double head ties can be used for installation of a second parallel cable run without the need for additional cable ties
- Material: Polyamide 6,6, UL94V-2
- Color: All colors are available

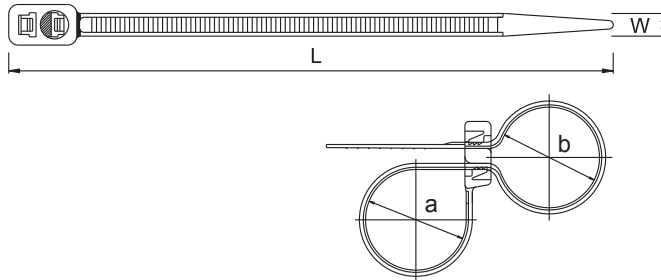

Part No.	Length (L) mm (inch)	Width (W) mm (inch)	Max.Bundle ϕ mm (inch)	Min. Loop Tensile Strength		
				N	kgf	lbf
GTB-200ST	195 (7.68)	4.8 (0.19)	a: ϕ 47 (1.85) b: ϕ 45 (1.77)	222	22.6	50
GTB-300ST	303 (11.93)	4.8 (0.19)	a: ϕ 72 (2.83) b: ϕ 70 (2.76)	222	22.6	50
GTB-370ST	372 (14.65)	4.8 (0.19)	a: ϕ 100 (3.94) b: ϕ 97 (3.82)	222	22.6	50

MOUNTABLE HEAD TIES

- These screw mount cable ties have a built in mounting holes
- Once fastened around the cables the bundle can be simply secured to the panel with a screw or bolt
- Material : Polyamide 6,6, UL94V-2
- Color: All colors are available



Part No.	Length (L) mm (inch)	Width (W) mm (inch)	Max.Bundle ϕ mm (inch)	Min. Loop Tensile Strength			Mounting Hole ϕ mm (inch)
				N	kgf	lbf	
GTM-110M	110 (4.33)	2.5 (0.10)	22 (0.87)	80	8.2	18	3.2 (0.13)
GTM-150I	150 (5.91)	3.6 (0.14)	32 (1.26)	178	18.2	40	4.2 (0.17)
GTM-200ST	200 (7.87)	4.8 (0.19)	47 (1.85)	222	22.6	50	5.2 (0.20)
GTM-216ST	216 (8.50)	4.8 (0.19)	53 (2.09)	222	22.6	50	5.2 (0.20)
GTM-300ST	309 (12.17)	4.8 (0.19)	76 (2.99)	222	22.6	50	5.2 (0.20)
GTM-370ST	380 (14.96)	4.8 (0.19)	102 (4.02)	222	22.6	50	5.2 (0.20)
GTM-200HD	215 (8.46)	7.6 (0.30)	47 (1.85)	534	54.5	120	5.7 (0.22)
GTM-300HD	313 (12.32)	7.6 (0.30)	76 (2.99)	534	54.5	120	5.7 (0.22)
GTM-380HD	382 (15.04)	7.6 (0.30)	98 (3.86)	534	54.5	120	5.7 (0.22)

BUTTON HEAD TIES

- For indoor use
- Used for normal bundling and through-panel applications
- Small head height allows more efficient use of space in compact areas
- Exclusive two-piece design offers the lowest threading force in the industry
- Releasable prior to final tensioning for bundle modifications
- Material: Polyamide 6,6, UL94V-2
- Color: All colors are available

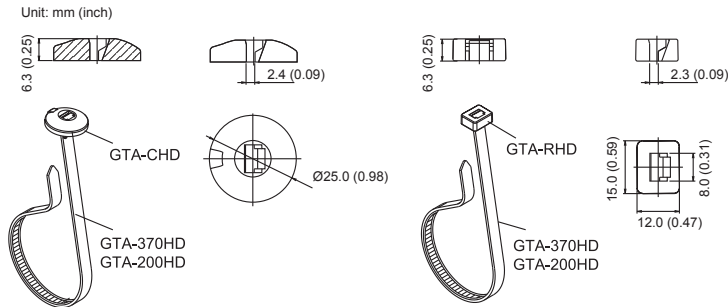

Part No.	Length (L) mm (inch)	Width (W) mm (inch)	Max.Bundle ø mm (inch)	Min. Loop Tensile Strength		
				N	kgf	lbf
GTA-200CHD	200 (7.87)	7.6 (0.30)	50 (1.97)	641	65.4	144
GTA-200RHD	200 (7.87)	7.6 (0.30)	50 (1.97)	641	65.4	144
GTA-370CHD	370 (14.57)	7.6 (0.30)	101 (3.98)	641	65.4	144
GTA-370RHD	370 (14.57)	7.6 (0.30)	101 (3.98)	641	65.4	144

OUTSIDE SERRATED TIES

- Outside serrated tie's serrated surface on the outside reducing the damage to the surface of the strapped object
- Material: Polyamide 6,6, UL94V-2
- Color: All colors are available

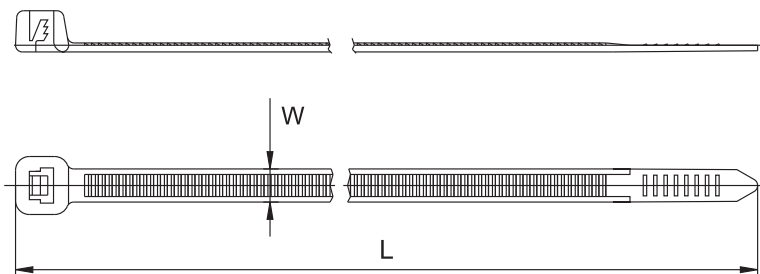

Part No.	Length (L) mm (inch)	Width (W) mm (inch)	Max.Bundle ø mm (inch)	Min. Loop Tensile Strength		
				N	kgf	lbf
GTPG-100M	100 (3.94)	2.5 (0.10)	22 (0.87)	80	8.2	18
GTPG-200ST	200 (7.87)	4.8 (0.19)	50 (1.97)	222	22.6	50
GTPG-300ST	300 (11.81)	4.8 (0.19)	76 (2.99)	222	22.6	50
GTPG-370ST	370 (14.57)	4.8 (0.19)	102 (4.02)	222	22.6	50
GTPG-390HD	390 (15.35)	7.6 (0.30)	110 (4.33)	534	54.5	120

BEAD TIES

- Reusable, easy to install and release
- Material: Polyamide 6,6, UL94V-2
- Color: All colors are available

GTB-100

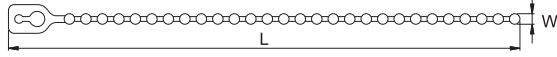

GTB-310

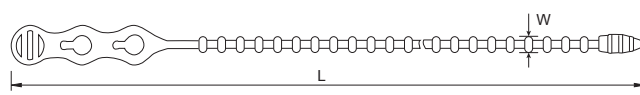

GTB-320

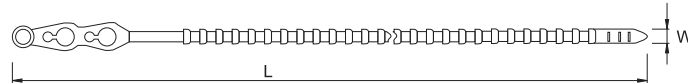

GTMB-90

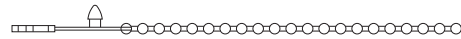
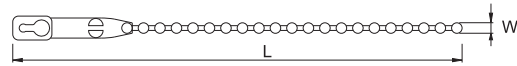

Part No.	Length (L) mm (inch)	Width (W) mm (inch)	Max.Bundle ø mm (inch)	Min. Loop Tensile Strength			Mounting Hole ø mm (inch)	Panel Thickness mm (inch)
				N	kgf	lbf		
GTB-100	107 (4.21)	2.3 (0.09)	29 (1.14)	40	4.1	9	--	--
GTB-310	316 (12.44)	4.4 (0.17)	80 (3.15)	311	31.8	70		
GTB-320	322 (12.68)	4.4 (0.17)	90 (3.54)	40	4.1	9	--	--
GTMB-90	93 (3.66)	2.4 (0.09)	25 (0.98)	40	4.1	9	3.0 (0.12)	1.6 (0.06)

STOP TIES

- Tie knuckle will prevent tightening on the object, forming a loop for sorting application
- Material: Polyamide 6,6, UL94V-2
- Color: All colors are available

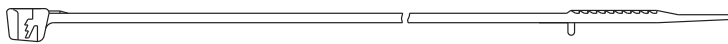

Part No.	Length (L) mm (inch)	Width (W) mm (inch)	Min.Bundle ø mm (inch)	Max.Bundle ø mm (inch)	Min. Loop Tensile Strength		
					N	kgf	lbf
GT-100MA	102 (4.02)	2.5 (0.10)	17.5 (0.69)	22 (0.87)	80	8.2	18
GT-150IA	150 (5.91)	3.6 (0.14)	22.5 (0.89)	35 (1.38)	178	18.2	40
GT-180IA	180 (7.09)	3.6 (0.14)	24.0 (0.94)	44 (1.73)	178	18.2	40
GT-300IA	300 (11.81)	3.6 (0.14)	84.5 (3.33)	88 (3.46)	178	18.2	40
GT-200HDA	203 (7.99)	7.6 (0.30)	29.3 (1.15)	50 (1.97)	534	54.5	120

PE TIES

- Application in garden, easy to install
- Releasable and reusable
- Material: PE
- Color: All colors are available

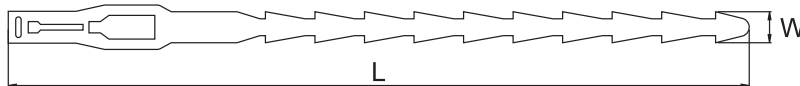

Part No.	Length (L) mm (inch)	Width (W) mm (inch)	Max.Bundle ø mm (inch)
AST-115	113 (4.45)	4.5 (0.18)	28 (1.10)
AST-173	167 (6.57)	5.2 (0.20)	45 (1.77)

AIR CONDITIONER TUBE TIES

- Special design for fixing air condition tube or water pipe
- Fix on the wall with screw or nail before fastening the pipe
- Material: PE
- Color: All colors are available

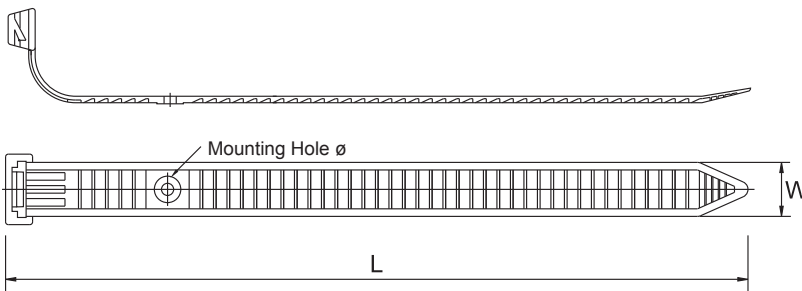

Part No.	Length (L) mm (inch)	Width (W) mm (inch)	Max.Bundle ø mm (inch)	Min. Loop Tensile Strength			Mounting Hole ø mm (inch)
				N	kgf	lbf	
BT-250	235 (9.25)	20.0 (0.78)	70 (2.76)	196	20.0	44	4.5 (0.18)
BT-290	275 (10.82)	20.0 (0.78)	80 (3.15)	196	20.0	44	4.5 (0.18)

LOW PROFILE CABLE TIES

- Better performance on chemical resistance, mechanical functions under low temperature environment
- Weather resistant cable tie for use in outdoor application
- Material: Polyamide 12, or Polyamide 6,6, weather resistant
- Color: Black

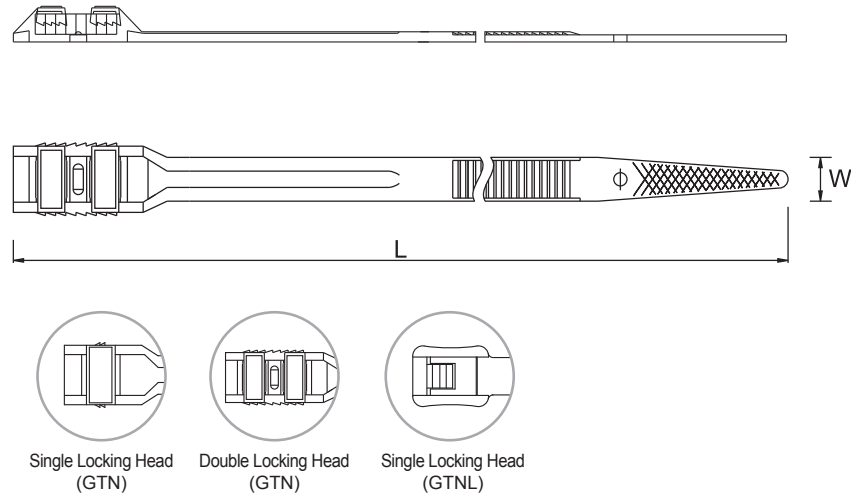

Fastening System
Cable Ties



Part No.	Material	Length (L) mm (inch)	Width (W) mm (inch)	Max. Bundle ϕ mm (inch)	Min. Loop Tensile Strength			Locking Device	
					N	kgf	lbf	Single	Double
GTN-180HD	PA12	180 (7.09)	8.6 (0.34)	40 (1.57)	343	35.0	77	•	
GTN-260HD	PA12	260 (10.24)	8.6 (0.34)	53 (2.09)	392	40.0	88		•
GTN-360HD	PA12	355 (13.98)	8.6 (0.34)	83 (3.27)	392	40.0	88		•
GTN-115STUV	PA66 UV	114 (4.47)	6.2 (0.24)	25 (0.98)	294	30.0	66	•	
GTN-180STUV	PA66 UV	175 (6.89)	6.2 (0.24)	40 (1.57)	294	30.0	66	•	
GTN-180HDUV	PA66 UV	180 (7.09)	8.6 (0.34)	40 (1.57)	343	35.0	77	•	
GTN-260HDUV	PA66 UV	260 (10.24)	8.6 (0.34)	53 (2.09)	392	40.0	88		•
GTN-360HDUV	PA66 UV	355 (13.98)	8.6 (0.34)	83 (3.27)	392	40.0	88		•
GTN-510HDUV	PA66 UV	515 (20.28)	8.9 (0.35)	138 (5.43)	534	54.5	120		•
GTN-750HDUV	PA66 UV	755 (29.72)	8.9 (0.35)	210 (8.27)	534	54.5	120		•
GTNL-360HDUV	PA66 UV	360 (14.17)	8.9 (0.35)	100 (3.93)	392	40.0	88	•	
GTNL-500HDUV	PA66 UV	482 (18.98)	8.9 (0.35)	135 (5.31)	392	40.0	88	•	

HOOK & LOOP CABLE TIES

- Low profile, one piece fastening device
- Constructed of polyethylene hook and polyamide loop, laminated back to back, this tie features quick release for repetitive access to cable and wire
- Reusable, adjustable, releasable and easy to install
- Its design provides ease of installation in tight areas such as telecommunications closets and will not get caught on other cables
- Available in a variety of colors and are versatile enough for applications ranging from network installations to bundling power cords
- Material: Polypropylene (female side), Polyamide (male side)
- Color: Black, white, red, yellow, blue, and green

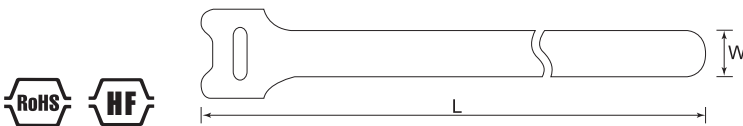

Part No.	Length (L) mm (inch)	Width (W) mm (inch)	Max.Bundle ø mm (inch)
VL-125	125 (4.92)	12.0 (0.47)	30 (1.18)
VL-130	130 (5.12)	12.0 (0.47)	32 (1.26)
VL-135	135 (5.31)	12.0 (0.47)	33 (1.30)
VL-155	155 (6.10)	12.0 (0.47)	40 (1.58)
VL-180	185 (7.28)	12.0 (0.47)	49 (1.93)
VL-210	210 (8.27)	12.0 (0.47)	55 (2.17)
VL-310	310 (12.20)	16.0 (0.63)	85 (3.35)

HOOK & LOOP CABLE TIE ROLL STRIPS

- Ideal for bundling & Strapping
- Versatile & adjustable
- Cut to Length as required
- Hook type: Mushroom hook and injection hook are available
- Material: Polypropylene (female side), Polypropylene (male side - mushroom hook), Polyamide (male side - injection hook)
- Color: Black



Part No.	Width mm (inch)	Length M (ft.)
VLR-1010	10.0 (0.39)	10 (32.8)
VLR-1025	10.0 (0.39)	25 (82.0)
VLR-1210	12.0 (0.47)	10 (32.8)
VLR-1225	12.0 (0.47)	25 (82.0)
VLR-1910	19.0 (0.75)	10 (32.8)
VLR-1925	19.0 (0.75)	25 (82.0)

INTRODUCTION OF HUA WEI'S STAINLESS STEEL TIES



The wide range of Hua Wei's stainless steel cable ties provide effective solution for the most demanding needs for fastening cables and pipes. With high resistance to various corrosive agents such as acids, alkali, UV, and rust, stainless steel cable ties can be used in all environments, including indoor, outdoor, heavy industrial, underground, and other hostile surroundings.

The characteristics of high strength and non-flammability make stainless steel ties ideal for high-temperature applications. These ties are also good fixing solution for traffic signs and outdoor decorations because of the UV and weather resistance features.

With chemicals and salt spray resistance, stainless steel becomes the best fastening solution for extreme environments such as mining, offshore and shipbuilding industries.

Advantage of Coated Stainless Steel Ties:

- Better protection of corrosion between dissimilar metals.
- Superior insulation between tie and strapped material.
- Better performance in chemical environments.
- Safe operation by decreasing cutting injuries.

BALL-LOCK TYPE

- Unique self-locking mechanism allows quick and reliable application. Low insertion force required.
- Both coated and uncoated products are available; Coated products provide excellent insulation and protection for cables and pipes. Uncoated tie is ideal for being applied for high temperature applications.
- Smooth edge and surface prevents cutting injury.
- Angled and round edge tail enables easier insertion



RELEASABLE TYPE

- Unique buckle design enables easy releasable feature before crimping of the "ears".
- Fully coated surface provides excellent insulation and protection for cables and pipes.
- Large round slot at the tail-end allows application of hook-type fastening tools.



FREE-END TYPE

- Separated tie and buckle for easy assembly.
- Three types of buckle for choice: Wing seal, teeth type and hex-screw.
- Flexible length of tie to satisfy users' different requirements.
- The additional ear can be bent over to increase the tensile strength.
- Coated products provide excellent insulation and protection for cables and pipes. Uncoated tie is ideal for being applied to extreme environment temperature applications.



MATERIAL & APPLICATION TABLE

Fastening System
 Stainless Steel Ties

Product Name	Ball Lock Type Stainless Steel Ties	Releasable Type Stainless Steel Ties	Wing Seal Type Stainless Steel Ties	Tiger Teeth Type Stainless Steel Ties
Type	MLG	MLR	MLW	MLT
Page	A-35	A-38	A-39	A-40
Material	SS 304 / 316	SS 304 / 316	SS 304 / 316	SS 304 / 316
Operating Temperature				
Max.	+500°C (932°F)	+500°C (932°F)	+500°C (932°F)	+500°C (932°F)
Min.	-80°C (-112°F)	-80°C (-112°F)	-80°C (-112°F)	-80°C (-112°F)
Resistant Properties				
UV light/ozone	⊙	⊙	⊙	⊙
Oils and greases	⊙	⊙	⊙	⊙
Solvents	⊙	⊙	⊙	⊙
Petrol	⊙	⊙	⊙	⊙
Flammability	⊙	⊙	⊙	⊙
Possible Applications				
Switch cabinets				
Electronics	☆	☆	☆	☆
Aerospace industries	☆	★		
Turbines and engines	★	★		
Telecommunications	★	★	★	★
Ship-building/Marine	★	★	★	★
Petrochemical/Offshore	★	★	★	★
Military industry	★	★	★	★
Public buildings	★	★	★	★
Automotives industries		★		
Sample Applications				
Bundling of cables and wires	★	★	★	★
Bundling of hoses	★	★	★	★
Extra heavy duty	★	★	★	★
Fastening heat insulation		★	★	★
Fastening dust insulation		★	★	★
Fastening traffic signs		★	★	★
Fastening signposts		★	★	★
Fasteing festival decorations		★	★	★
Fastening commercial signs		★	★	★
Fastening electrical pole		★	★	★
Fastening electronic pipe		★		
Fastening marker plates	★	★		
Post-installation fastening			★	★
Temporary fastening	★	★	★	★
Underwater use	★	★		
Identification of pipes				

⊙ Excellent ⊙ Good △ Medium ★ Suitable ☆ Partly Suitable

MATERIAL & APPLICATION TABLE

Product Name	Stainless Steel Strapping	Stainless Steel Buckles	Stainless Steel Marker Plates
Type	MLF-HD	MLW-BK MLT-BK	GMP
Page	A-41	A-41	A-41
Material	SS 304 / 316	SS 304 / 316	SS 304 / 316
Operating Temperature			
Max.	+500°C (932°F)	+500°C (932°F)	+500°C (932°F)
Min.	-80°C (-112°F)	-80°C (-112°F)	-80°C (-112°F)
Resistant Properties			
UV light/ozone	⊙	⊙	⊙
Oils and greases	⊙	⊙	⊙
Solvents	⊙	⊙	⊙
Petrol	⊙	⊙	⊙
Flammability	⊙	⊙	⊙
Possible Applications			
Switch cabinets			☆
Electronics			
Aerospace industries			
Turbines and engines			★
Telecommunications	★	★	★
Ship-building/Marine	★	★	★
Petrochemical/Offshore			★
Military industry	★	★	★
Public buildings	★	★	
Automotives industries			
Sample Applications			
Bundling of cables and wires	★	★	
Bundling of hoses	★	★	
Extra heavy duty	★	★	
Fastening heat insulation	★	★	
Fastening dust insulation	★	★	
Fastening traffic signs	★	★	
Fastening signposts	★	★	
Fastening festival decorations	★	★	
Fastening commercial signs	★	★	
Fastening electrical pole	★	★	
Fastening electronic pipe	★	★	
Fastening marker plates			
Post-installation fastening	★	★	
Temporary fastening	★	★	
Underwater use			
Identification of pipes			★

⊙ Excellent ⊖ Good △ Medium ★ Suitable ☆ Partly Suitable

STAINLESS STEEL TIES ORDERING SPECIFICATION

MLG – **130** **ST** **Y**
1 **2** **3** **4**

- 1** Type ● MLG = Ball lock type
 ● MLR = Releasable type
 ● MLW = Wing seal type
 ● MLT = Tiger teeth type
- 2** Length
- 3** Width ● ST = Standard
 ● HD = Heavy duty
- 4** Coating Material ● No Suffix = non-coating
 ● E = Epoxy
 ● Y = Polyamide 11
 ● V = Polyvinyl Chloride

MLF – **30** **HD** **95** **06** **P**
1 **2** **3** **3a** **3b** **4**

- 1** Type ● MLF = Free-end type
- 2** Length
- 3** Width
- 3a** Width
- 3b** Thickness
- 4** Package ● No Suffix = Paper box
 ● P = Plastic tote

STAINLESS STEEL MATERIAL DESCRIPTIONS

Material	Operation Temp.		Flame Rating	UV Resistance	Salt Spray Resistance	Chemicals Resistance	Antistatic
	Max.	Min.					
Stainless Steel Type: # 304	500°C 932°F	-80°C -112°F	Non flammable	◎	○	◎	◎
Stainless Steel Type: # 316	500°C 932°F	-80°C -112°F	Non flammable	◎	◎	◎	◎

◎ Excellent ○ Good △ Medium

COATING MATERIAL DESCRIPTIONS

Material	Operation Temperature		Abrasion Resistance	Impact Resistance	Adhesion	Alkali Resistance	Acid Resistance	Salt Spray Resistance	Loop Tensile
	Max.	Min.							
Epoxy (ED)	150°C 302°F	-80°C -112°F	○	○	○	○	○	○	○
Polyvinyl Chloride (PVC)	85°C 185°F	-40°C -40°F	◎	◎	○	○	○	◎	△

◎ Excellent ○ Good △ Medium

STAINLESS STEEL CABLE TIES - BALL-LOCK UNCOATED TIES

Fastening System
Stainless Steel Ties

Ball lock type stainless steel cable ties of unique self-locking mechanism allows quick and reliable application with low insertion force required. Both of coated and uncoated products are available; Coated products provide excellent insulation and protection for cables and pipes. Uncoated tie is ideal for being applied for extreme environment temperature applications.

Product Feature:

Uncoated version, for high temperature applications



Applications:

ideal for petrochemical, food industry, industries, power stations, mining, ship-building, offshore and any other aggressive environments.

Technical Information:

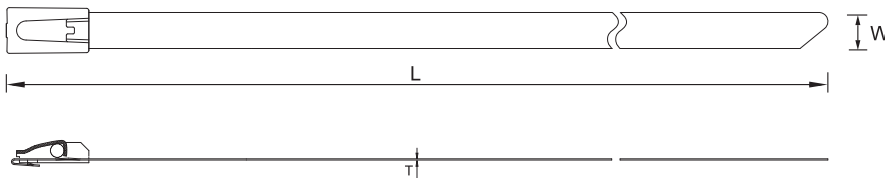
- Material: Stainless Steel Grade 304 or 316
304 grade stainless steel, for standard applications
316 grade stainless steel, for extra corrosive environments
- Working Temp.: -60°C to 300°C
- Description: Metallic band and buckle
- Flammability: Fireproof
- Other Properties: UV-resistant.



Part No.	Length (L) mm (inch)	Width (W) mm (inch)	Thickness (T) mm (inch)	Max.Bundle ø mm (inch)	Min. Loop Tensile Strength			Recommended Tensioning tools
					N	kgf	lbf	
MLG-130ST	130 (5.08)	4.6 (0.18)	0.26 (0.01)	33 (1.30)	445	45.4	100	
MLG-152ST	150 (5.91)	4.6 (0.18)	0.26 (0.01)	40 (1.57)	445	45.4	100	
MLG-200ST	200 (7.87)	4.6 (0.18)	0.26 (0.01)	50 (1.97)	445	45.4	100	
MLG-280ST	280 (11.02)	4.6 (0.18)	0.26 (0.01)	70 (2.76)	445	45.4	100	
MLG-300ST	300 (11.81)	4.6 (0.18)	0.26 (0.01)	76 (2.99)	445	45.4	100	
MLG-370ST	370 (14.57)	4.6 (0.18)	0.26 (0.01)	102 (4.02)	445	45.4	100	
MLG-520ST	520 (20.47)	4.6 (0.18)	0.26 (0.01)	156 (6.14)	445	45.4	100	
MLG-680ST	680 (26.77)	4.6 (0.18)	0.26 (0.01)	207 (8.15)	445	45.4	100	
MLG-840ST	840 (33.07)	4.6 (0.18)	0.26 (0.01)	257 (10.12)	445	45.4	100	
MLG-1050ST	1050 (41.34)	4.6 (0.18)	0.26 (0.01)	319 (12.56)	445	45.4	100	
MLG-152HD	150 (5.91)	7.9 (0.31)	0.26 (0.01)	40 (1.57)	1112	113.4	250	
MLG-200HD	200 (7.76)	7.9 (0.31)	0.26 (0.01)	50 (1.97)	1112	113.4	250	
MLG-300HD	300 (11.81)	7.9 (0.31)	0.26 (0.01)	76 (2.99)	1112	113.4	250	
MLG-370HD	370 (14.49)	7.9 (0.31)	0.26 (0.01)	102 (4.02)	1112	113.4	250	
MLG-450HD	450 (17.72)	7.9 (0.31)	0.26 (0.01)	135 (5.31)	1112	113.4	250	
MLG-500HD	500 (19.69)	7.9 (0.31)	0.26 (0.01)	150 (5.91)	1112	113.4	250	
MLG-680HD	680 (26.77)	7.9 (0.31)	0.26 (0.01)	207 (8.15)	1112	113.4	250	
MLG-720HD	720 (28.35)	7.9 (0.31)	0.26 (0.01)	216 (8.50)	1112	113.4	250	
MLG-840HD	840 (33.07)	7.9 (0.31)	0.26 (0.01)	257 (10.12)	1112	113.4	250	
MLG-1020HD	1020 (40.16)	7.9 (0.31)	0.26 (0.01)	312 (12.28)	1112	113.4	250	
MLG-1050HD	1050 (41.34)	7.9 (0.31)	0.26 (0.01)	319 (12.56)	1112	113.4	250	

STAINLESS STEEL CABLE TIES - BALL-LOCK EPOXY COATED TIES

Ball lock type stainless steel cable ties of unique self-locking mechanism allows quick and reliable application with low insertion force required. Both of coated and uncoated products are available; Coated products provide excellent insulation and protection for cables and pipes. Uncoated tie is ideal for being applied for extreme environment temperature applications.



Product Feature:

- Coated band with non-toxic, halogen free polyester coating
- Provides additional edge protection
- Prevents the corrosion between dissimilar materials.
- Metallic buckle helps to distinguish from black nylon tie.

Applications:

Ideal for petrochemical, Industries, power stations, mining, ship-building, offshore, and other aggressive environments.

Technical Information:

- Material: Stainless Steel Grade 304 or 316
304 grade stainless steel, for standard applications
316 grade stainless steel, for extra corrosive environments
- Working Temp.: -80°C to 150°C
- Description: Black Band with Metallic Buckle
- Flammability: Fireproof
- Other Properties: UV-resistant, non toxic

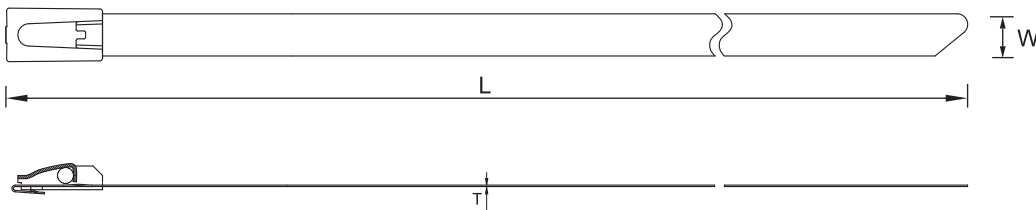

Part No.	Length (L) mm (inch)	Width (W) mm (inch)	Thickness (T) mm (inch)	Max.Bundle ø mm (inch)	Min. Loop Tensile Strength		
					N	kgf	lbf
MLG-130STE	130 (5.08)	4.6 (0.18)	0.39 (0.014)	33 (1.30)	600	72.4	135
MLG-200STE	200 (7.87)	4.6 (0.18)	0.39 (0.014)	50 (1.97)	600	72.4	135
MLG-300STE	300 (11.81)	4.6 (0.18)	0.39 (0.014)	76 (2.99)	600	72.4	135
MLG-370STE	370 (14.57)	4.6 (0.18)	0.39 (0.014)	102 (4.02)	600	72.4	135
MLG-520STE	520 (20.47)	4.6 (0.18)	0.39 (0.014)	156 (6.14)	600	72.4	135
MLG-680STE	680 (26.77)	4.6 (0.18)	0.39 (0.014)	207 (8.15)	600	72.4	135
MLG-840STE	840 (33.07)	4.6 (0.18)	0.39 (0.014)	257 (10.10)	600	72.4	135
MLG-1050STE	1050 (41.34)	4.6 (0.18)	0.39 (0.014)	319 (12.56)	600	72.4	135
MLG-200HDE	200 (7.76)	7.9 (0.31)	0.39 (0.014)	50 (1.97)	800	114	180
MLG-300HDE	300 (11.81)	7.9 (0.31)	0.39 (0.014)	76 (3.00)	800	114	180
MLG-370HDE	370 (14.49)	7.9 (0.31)	0.39 (0.014)	102 (4.02)	800	114	180
MLG-450HDE	450 (17.72)	7.9 (0.31)	0.39 (0.014)	115 (4.50)	800	114	180
MLG-500HDE	500 (19.69)	7.9 (0.31)	0.39 (0.014)	128 (5.00)	800	114	180
MLG-680HDE	680 (26.77)	7.9 (0.31)	0.39 (0.014)	207 (8.15)	800	114	180
MLG-720HDE	720 (28.35)	7.9 (0.31)	0.39 (0.014)	216 (8.50)	800	114	180
MLG-840HDE	840 (33.07)	7.9 (0.31)	0.39 (0.014)	257 (10.10)	800	114	180
MLG-1020HDE	1020 (40.16)	7.9 (0.31)	0.39 (0.014)	312 (12.30)	800	114	180
MLG-1050HDE	1050 (41.34)	7.9 (0.31)	0.39 (0.014)	319 (12.56)	800	114	180

STAINLESS STEEL CABLE TIES - BALL-LOCK PVC COATED TIES

Ball lock type stainless steel cable ties of unique self-locking mechanism allows quick and reliable application with low insertion force required. Both of coated and uncoated products are available; Coated products provide excellent insulation and protection for cables and pipes. Uncoated tie is ideal for being applied for extreme environment temperature applications.

Product Feature:

- Metallic buckle helps to distinguish from black nylon tie.
- PVC coating is thicker and softer.
- Prevents corrosion between dissimilar metals.
- Provide additional edge protection.

Applications:

Ideal for petrochemical, industries, power stations, mining, ship-building, offshore, and other aggressive environments.

Technical Information:

- Material: Stainless Steel Grade 304 or 316
304 grade stainless steel, for standard applications
316 grade stainless steel, for extra corrosive environments
- Coating: PVC
- Working Temp.: -40°C to 85°C
- Description: Black Band with Metallic Buckle
- Flammability: Fireproof
- Other Properties: UV-resistant is available

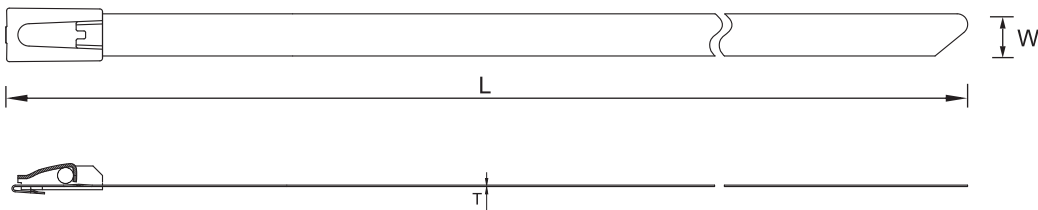

Part No.	Length (L) mm (inch)	Width (W) mm (inch)	Thickness (T) mm (inch)	Max.Bundle ø mm (inch)	Min. Loop Tensile Strength		
					N	kgf	lbf
MLG-150STV	150 (5.9)	5.6 (0.22)	1 (0.039)	37 (1.46)	350	35.7	80
MLG-200STV	200 (7.9)	5.6 (0.22)	1 (0.039)	50 (1.97)	350	35.7	80
MLG-250STV	250 (9.8)	5.6 (0.22)	1 (0.039)	63 (2.48)	350	35.7	80
MLG-350STV	350 (13.8)	5.6 (0.22)	1 (0.039)	89 (3.50)	350	35.7	80
MLG-450STV	450 (17.7)	5.6 (0.22)	1 (0.039)	115 (4.53)	350	35.7	80
MLG-600STV	600 (23.6)	5.6 (0.22)	1 (0.039)	154 (6.06)	350	35.7	80
MLG-750STV	750 (29.5)	5.6 (0.22)	1 (0.039)	178 (7.01)	350	35.7	80
MLG-900STV	900 (35.4)	5.6 (0.22)	1 (0.039)	229 (9.02)	350	35.7	80
MLG-200HDV	200 (7.8)	9.0 (0.35)	1 (0.039)	52 (2.05)	445	45.9	100
MLG-250HDV	250 (11.8)	9.0 (0.35)	1 (0.039)	65 (2.56)	445	45.9	100
MLG-300HDV	300 (14.5)	9.0 (0.35)	1 (0.039)	78 (3.07)	445	45.9	100
MLG-400HDV	400 (17.7)	9.0 (0.35)	1 (0.039)	102 (4.02)	445	45.9	100
MLG-500HDV	500 (19.7)	9.0 (0.35)	1 (0.039)	128 (5.04)	445	45.9	100
MLG-650HDV	650 (26.8)	9.0 (0.35)	1 (0.039)	165 (6.50)	445	45.9	100
MLG-800HDV	800 (31.5)	9.0 (0.35)	1 (0.039)	204 (8.03)	445	45.9	100
MLG-1000HDV	1000 (33.1)	9.0 (0.35)	1 (0.039)	254 (10.00)	445	45.9	100

RELEASABLE TYPE STAINLESS STEEL TIES

Fastening System
Stainless Steel Ties

- This product is releasable and can be double-wrapped for additional tensile strength
- Polyamide coating provides additional edge protection and prevents corrosion between dissimilar metals
- AISI 316 stainless steel for the most corrosive environments
- UV resistant, low smoke, halogen-free material
- Material: Stainless steel type: #304, 316
Coating: Epoxy and Polyamide are available
- Length: All lengths are available

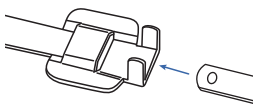
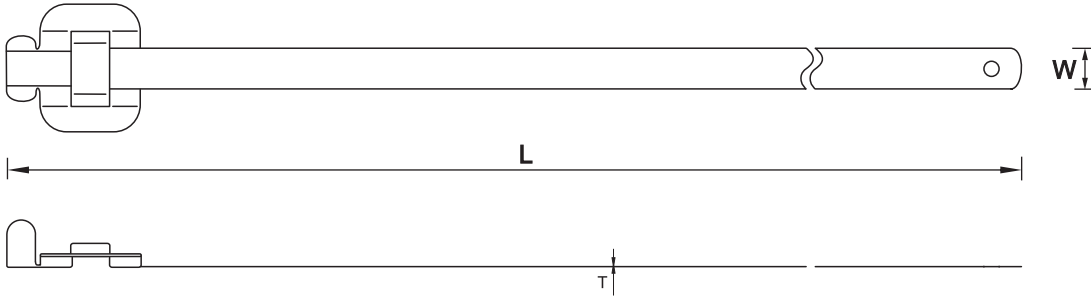

Insert the tail into the buckle.

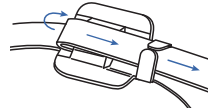

Thread the tie through buckle, then tighten the bundle with crimping tool. Fold over the remaining tail of tie and secure by hammering down the ears of buckle. The remaining tie may be cut to finish the process.



Part No.	Length (L) mm (inch)	Width (W) mm (inch)	Thickness (T) mm (inch)	Max.Bundle ø mm (inch)	Min. Loop Tensile Strength		
					N	kgf	lbf
MLR-150ST	150 (5.90)	6.4 (0.25)	0.38 (0.02)	38 (1.50)	334	34.1	75
MLR-230ST	230 (9.05)	6.4 (0.25)	0.38 (0.02)	63 (2.48)	334	34.1	75
MLR-305ST	305 (12.00)	6.4 (0.25)	0.38 (0.02)	86 (3.39)	334	34.1	75
MLR-460ST	460 (18.11)	6.4 (0.25)	0.38 (0.02)	137 (5.39)	334	34.1	75
MLR-610ST	610 (24.01)	6.4 (0.25)	0.38 (0.02)	185 (7.28)	334	34.1	75
MLR-150HD	150 (5.90)	9.6 (0.38)	0.38 (0.02)	38 (1.50)	1112	113.4	250
MLR-230HD	230 (9.05)	9.6 (0.38)	0.38 (0.02)	63 (2.48)	1112	113.4	250
MLR-305HD	305 (12.00)	9.6 (0.38)	0.38 (0.02)	86 (3.39)	1112	113.4	250
MLR-460HD	460 (18.11)	9.6 (0.38)	0.38 (0.02)	137 (5.39)	1112	113.4	250
MLR-610HD	610 (24.01)	9.6 (0.38)	0.38 (0.02)	185 (7.28)	1112	113.4	250

WING SEAL TYPE STAINLESS STEEL TIES

Fastening System
Stainless Steel Ties

- Available with various widths to choose from: 9.5 mm, 12.7 mm, 15.9 mm, 19.0 mm
- Protuberating wing structure design delivers advantages of speed installation and secured fastening
- Low profile tie head design, which is ideal for use in the restricted space
- Available with polyamide or epoxy resin coating options, which provide better protection on the tie body edges and prevent rust generation on metals from direct physical contact
- Adaptable to most of the harsh environment circumstances by delivering superior fastening capability and tensile
- Material: Stainless steel type: #304, 316
Coating: Epoxy, Polyamide and Polyvinyl Chloride are available
- Length: All lengths are available

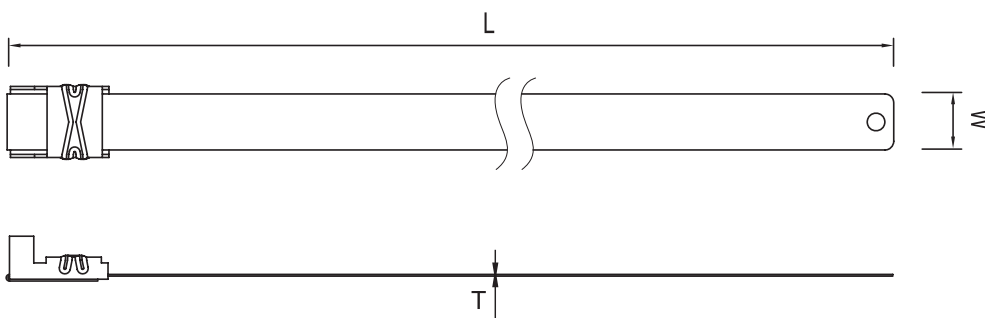

Part No.	Length (L) mm (inch)	Width (W) mm (inch)	Thickness (T) mm (inch)	Max. Bundle ϕ mm (inch)	Min. Loop Tensile Strength		
					N	kgf	lbf
MLW-3003HD	300 (11.81)	9.5 (0.37)	0.38 (0.02)	70 (2.76)	2225	227.0	500
MLW-4003HD	400 (15.75)	9.5 (0.37)	0.38 (0.02)	100 (3.94)	2225	227.0	500
MLW-5003HD	500 (19.69)	9.5 (0.37)	0.38 (0.02)	130 (5.12)	2225	227.0	500
MLW-6003HD	600 (23.62)	9.5 (0.37)	0.38 (0.02)	165 (6.50)	2225	227.0	500
MLW-3004HD	300 (11.81)	12.7 (0.50)	0.38 (0.02)	70 (2.76)	3115	317.6	700
MLW-4004HD	400 (15.75)	12.7 (0.50)	0.38 (0.02)	100 (3.94)	3115	317.6	700
MLW-5004HD	500 (19.69)	12.7 (0.50)	0.38 (0.02)	130 (5.12)	3115	317.6	700
MLW-6004HD	600 (23.62)	12.7 (0.50)	0.38 (0.02)	165 (6.50)	3115	317.6	700
MLW-3005HD	300 (11.81)	15.9 (0.63)	0.38 (0.02)	70 (2.76)	3560	363.0	800
MLW-4005HD	400 (15.75)	15.9 (0.63)	0.38 (0.02)	100 (3.94)	3560	363.0	800
MLW-5005HD	500 (19.69)	15.9 (0.63)	0.38 (0.02)	130 (5.12)	3560	363.0	800
MLW-6005HD	600 (23.62)	15.9 (0.63)	0.38 (0.02)	165 (6.50)	3560	363.0	800
MLW-3006HD	300 (11.81)	19.0 (0.75)	0.38 (0.02)	70 (2.76)	4450	453.8	1000
MLW-4006HD	400 (15.75)	19.0 (0.75)	0.38 (0.02)	100 (3.94)	4450	453.8	1000
MLW-5006HD	500 (19.69)	19.0 (0.75)	0.38 (0.02)	130 (5.12)	4450	453.8	1000
MLW-6006HD	600 (23.62)	19.0 (0.75)	0.38 (0.02)	165 (6.50)	4450	453.8	1000

TIGER TEETH TYPE STAINLESS STEEL TIES

- Available with various widths to choose from: 9.5 mm, 12.7 mm, 15.9 mm, 19.0 mm
- Protuberating L structure with serrated anti-locking design delivers advantages of speed installation and superior reliability
- Available with polyamide or epoxy resin coating options, which provide better protection on the tie body edges and prevent rust generation on metals from direct physical contact
- Applicable for use by a wide variety of industries inclusive of mess transportation, public signage, oil rig drilling, mining, chemical, and power generation etc. that require reliable fastening accessories
- Solid stainless steel with advantages of abrasive resistance, acid & alkali resistance, weathering resistance and flame resistance
- Material: Stainless steel type: #304, 316
Coating: Epoxy, Polyamide and Polyvinyl Chloride are available
- Length: All lengths are available

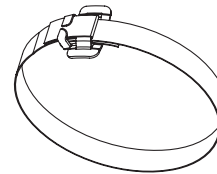
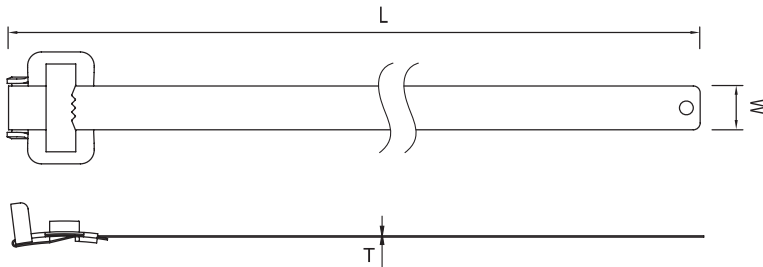

Part No.	Length (L) mm (inch)	Width (W) mm (inch)	Thickness (T) mm (inch)	Max.Bundle ø mm (inch)	Min. Loop Tensile Strength		
					N	kgf	lbf
MLT-3003HD	300 (11.81)	9.5 (0.37)	0.38 (0.02)	70 (2.76)	2225	227.0	500
MLT-4003HD	400 (15.75)	9.5 (0.37)	0.38 (0.02)	100 (3.94)	2225	227.0	500
MLT-5003HD	500 (19.69)	9.5 (0.37)	0.38 (0.02)	130 (5.12)	2225	227.0	500
MLT-6003HD	600 (23.62)	9.5 (0.37)	0.38 (0.02)	165 (6.50)	2225	227.0	500
MLT-3004HD	300 (11.81)	12.7 (0.50)	0.38 (0.02)	70 (2.76)	3115	317.6	700
MLT-4004HD	400 (15.75)	12.7 (0.50)	0.38 (0.02)	100 (3.94)	3115	317.6	700
MLT-5004HD	500 (19.69)	12.7 (0.50)	0.38 (0.02)	130 (5.12)	3115	317.6	700
MLT-6004HD	600 (23.62)	12.7 (0.50)	0.38 (0.02)	165 (6.50)	3115	317.6	700
MLT-3005HD	300 (11.81)	15.9 (0.63)	0.38 (0.02)	70 (2.76)	3560	363.0	800
MLT-4005HD	400 (15.75)	15.9 (0.63)	0.38 (0.02)	100 (3.94)	3560	363.0	800
MLT-5005HD	500 (19.69)	15.9 (0.63)	0.38 (0.02)	130 (5.12)	3560	363.0	800
MLT-6005HD	600 (23.62)	15.9 (0.63)	0.38 (0.02)	165 (6.50)	3560	363.0	800
MLT-3006HD	300 (11.81)	19.0 (0.75)	0.38 (0.02)	70 (2.76)	4450	453.8	1000
MLT-4006HD	400 (15.75)	19.0 (0.75)	0.38 (0.02)	100 (3.94)	4450	453.8	1000
MLT-5006HD	500 (19.69)	19.0 (0.75)	0.38 (0.02)	130 (5.12)	4450	453.8	1000
MLT-6006HD	600 (23.62)	19.0 (0.75)	0.38 (0.02)	165 (6.50)	4450	453.8	1000

STAINLESS STEEL STRAPPING & BUCKLES

- Applied with stainless steel buckles: MLW-BK and MLT-BK
- Tie length or bundle diameter can be adjusted by users
- Fit for hoses of all sizes
- Convenient and durable for mounting traffic signs, commercial signs, holiday decorations, etc.
- Material: Stainless steel type: #304, 316
- Length: 30 M / 100 ft. per roll



Paper Box



Plastic Tote



MLW-BK

MLT-BK

Part No.		Length M (ft.)	Width mm (inch)	Thickness mm (inch)	Recommended Tensioning Tools
Paper Box	Plastic Tote				
MLF-30HD-9506	MLF-30HD-9506P	30 (100)	9.5 (0.37)	0.58 (0.02)	<p>GIT-260</p>
MLF-30HD-1207	MLF-30HD-1207P	30 (100)	12.7 (0.50)	0.70 (0.03)	
MLF-30HD-1607	MLF-30HD-1607P	30 (100)	15.9 (0.63)	0.70 (0.03)	
MLF-30HD-1907	MLF-30HD-1907P	30 (100)	19.0 (0.75)	0.70 (0.03)	
MLF-30HD-9504	MLF-30HD-9504P	30 (100)	9.5 (0.37)	0.38 (0.02)	
MLF-30HD-1204	MLF-30HD-1204P	30 (100)	12.7 (0.50)	0.38 (0.02)	
MLF-30HD-1604	MLF-30HD-1604P	30 (100)	15.9 (0.63)	0.38 (0.02)	
MLF-30HD-1904	MLF-30HD-1904P	30 (100)	19.0 (0.75)	0.38 (0.02)	

- Fits 9.5 mm, 12.7 mm, 15.9 mm, 19.0 mm strapping
- Easy to be assembled. Ties may be released and reused before fastened
- Material: Stainless steel type: #304, 316



Part No.	Type	Max. Tie Width mm (inch)
MLW-BK-3	Wing Seal	9.5 (0.37)
MLW-BK-4	Wing Seal	12.7 (0.50)
MLW-BK-5	Wing Seal	15.9 (0.63)
MLW-BK-6	Wing Seal	19.0 (0.75)

Part No.	Type	Max. Tie Width mm (inch)
MLT-BK-3	Tiger Teeth	9.5 (0.37)
MLT-BK-4	Tiger Teeth	12.7 (0.50)
MLT-BK-5	Tiger Teeth	15.9 (0.63)
MLT-BK-6	Tiger Teeth	19.0 (0.75)

STAINLESS STEEL MARKER PLATES

- Applicable for use at ducts, pipes, valves, power cables, chemical petroleum devices, oil refining plants, and other harsh environments
- Quality resistance to abrasion, corrosion and UV that enables the tie adaptable to most of the harsh environment circumstances by providing long-lasting indication performance
- Advantages of speed installation and low cost
- Material: Stainless steel type: #304, 316

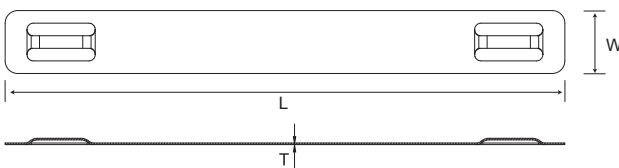

Part No.	Length (L) mm (inch)	Width (W) mm (inch)	Thickness (T) mm (inch)	Max. 4.77mm (3/16") Characters Per Line	Max. Lines	Max. Tie Width mm (inch)
GMP-8910R	89 (3.50)	10 (0.39)	0.25 (0.01)	23	1	8.0 (0.31)
GMP-8919R	89 (3.50)	19 (0.75)	0.25 (0.01)	23	3	8.0 (0.31)

INTRODUCTION OF ENGINEERING FASTENERS

Fastening System
Engineering Fasteners



Optimized Quality Leading in The Industry

With over 30 year experience on precise stamping and precise molding injection, Hua Wei has provided industrial standard cable ties and fasteners, and customized variable automotive and engineering fasteners to fulfill the unique requirement of secure and sustainable. Engineering fasteners of Hua Wei apply to high vibration and harsh environment and can fasten wires securely. Applicable all kinds of vehicles, aviation, machinery, etc.

Technologies of precise stamping and molding injection, excellent RD teamwork, and premium quality make Hua Wei the first choices as an industrial OEM service provider and partner.

Design and Development of Fasteners

Many of cable ties and engineering fasteners are specially designed for unique requirement to sustainable for high vibration environment or in the high temperature of engine compartment. Some of the cable ties are convenient to apply without using tools to insert into pre-drilled holes and fix. Some are free to rotate the wires when fixed on board. Some are with high tensile strength and suitable for trunks or large vehicles.

Frequently, we use complex material to enhance the fixture and secure. Edge clips are embedded

with steel clamp and can be tightly clipped to metal boards without slips and can not remove easily. Some fasteners add additional seal to absorb vibration and protect against water drip.

Engineering fasteners developed by Hua Wei hold both advantages of durable in structure and light weight, thus suitable for apply to airplanes to decrease the consuming of gasoline. Through ISO/TS16949 management system, the optimized performance of Hua Wei's fasteners are reliable as the vehicles/machinery should be.

Cooperate and Develop New Product with Customer

Hua Wei employs Computer-Aid Engineering Analysis in the RD process to prevent development failure of product in early period and to raise the efficiency and success rate of new product design and development.

Our outstanding and experienced technical team members and excellent team work, devote to assist customers to develop new product to satisfy the unique application requirement.

Combining our expertise of materials, electrical design, precise stamping, and precise molding injection, great flexibility is allowed in our production, and we are enabled to develop products jointly with our customers.

Automotive Fasteners Application



DESIGN AND SELECTION OF ENGINEERING FASTENERS

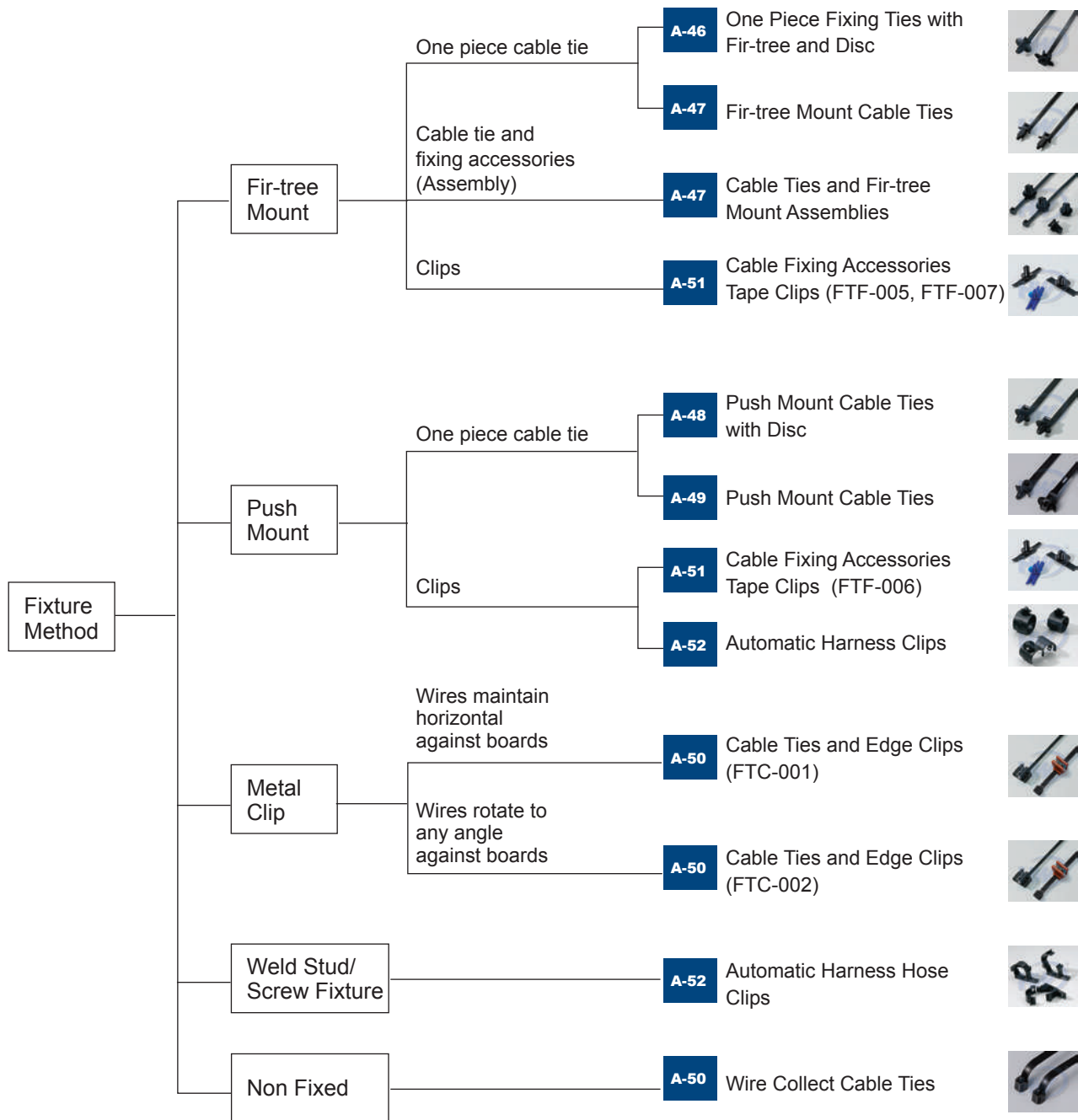

Fastening System
Engineering Fasteners

- Features of Hua Wei's Engineering Fasteners:**
- ✓ Safety: Fasten and fix securely.
 - ✓ Insulation: Separate from board or weld stud.
 - ✓ Durability: Suitable to used in high vibration environment.
 - ✓ Efficiency: Design for quick bundling and fastening, decrease the use of tools
 - ✓ Heat resistant: Heat resistant material are available and suitable for higher temperature application, ex. engine compartment

MATERIAL & APPLICATION TABLE

Product Name	One Piece Fixing Ties with Fir-tree and Disc	Cable Ties and Fir-Tree Mount Assemblies	Fir-Tree Mount Cable Ties	Push Mount Cable Ties with Disc	Push Mount Cable Ties
Type	-	-	-	-	-
Page	A-46	A-47	A-47	A-48	A-49
Material	Polyamide 6,6	Polyamide 6,6	Polyamide 6,6	Polyamide 6,6	Polyamide 6,6
Operating Temperature					
Max.	85°C (185°F)	85°C (185°F)	85°C (185°F)	85°C (185°F)	85°C (185°F)
Min.	-40°C (-40°F)	-40°C (-40°F)	-40°C (-40°F)	-40°C (-40°F)	-40°C (-40°F)
Resistant Properties					
UV light/ozone	△	△	△	△	△
Oils and greases	◎	◎	◎	◎	◎
Solvents	○	○	○	○	○
Petrol	◎	◎	◎	◎	◎
Flammability	UL94V-2	UL94V-2	UL94V-2	UL94V-2	UL94V-2
Possible Applications					
Switch cabinets	★	★	★	★	★
Electronics	★	★	★	★	★
Aerospace industries	★	★	★	★	★
Turbines and engines	★	★	★	★	★
Telecommunications					
Ship-building/Marine	★	★	★	★	★
Military industry	★	★	★	★	★
Harnessmakers					
Public buildings	★	★	★	★	★
Automotives industries	★	★	★	★	★
Sample Applications					
Bundling of cables and wires	★	★	★	★	★
Bundling of hoses	★	★	★	★	★
Welded or threaded studs			★		
Drilled hole with thread	★	★	★		★
Edge fastening on steel plated					
Blind holes with thread	★	★	★		
Bundling of optical cables	★	★	★		★
Fastening optical cables	★	★	★		★
For restricted space	★	★	★		★
Post-installation fastening	★	★	★		★

◎ Excellent ○ Good △ Medium ★ Suitable ☆ Partly Suitable

Product Name	Wire Collect Cable Ties	Cable Ties and Edge Clips	Cable Fixing Accessories Tape Clips	Automatic Harness Clips	Automatic Harness Hose Clips
Type	-	-	-	-	-
Page	A-50	A-50	A-51	A-52	A-52
Material	Polyamide 6,6	Polyamide 6,6	Polyamide 6,6	Polyamide 6,6	Polyamide 6,6
Operating Temperature					
Max.	85°C (185°F)	85°C (185°F)	85°C (185°F)	85°C (185°F)	85°C (185°F)
Min.	-40°C (-40°F)	-40°C (-40°F)	-40°C (-40°F)	-40°C (-40°F)	-40°C (-40°F)
Resistant Properties					
UV light/ozone	△	△	△	△	△
Oils and greases	◎	◎	◎	◎	◎
Solvents	○	○	○	○	○
Petrol	◎	◎	◎	◎	◎
Flammability	UL94V-2	UL94V-2	UL94V-2	UL94V-2	UL94V-2
Possible Applications					
Switch cabinets	★	★	☆	★	★
Electronics	★	★	★	★	★
Aerospace industries	★			★	
Turbines and engines	★			★	
Telecommunications				★	★
Ship-building/Marine	★			★	★
Military industry				★	★
Harnessmakers	★			★	
Public buildings					☆
Automotives industries	★	★	★	★	★
Sample Applications					
Bundling of cables and wires	★	★	★	★	★
Bundling of hoses	★	★		★	★
Welded or threaded studs				☆	★
Drilled hole with thread	★		★	★	★
Edge fastening on steel plated		★			
Blind holes with thread			☆		
Bundling of optical cables	★				
Fastening optical cables	★			★	
For restricted space	★		☆	☆	☆
Post-installation fastening	★			★	

◎ Excellent ○ Good △ Medium ★ Suitable ☆ Partly Suitable

ONE PIECE FIXING TIES WITH FIR-TREE AND DISC

Fastening System
Engineering Fasteners

- One-piece fir-tree design with disc is similar to push mount cable ties but the disc can enhance the stability of fixing and avoid dust and water invasion
- Additional cured tab below the buckle will fasten and maintain bundles on the axial
- Fir-tree push mount design applied to various thickness of board or one-side thread hole
- Applied to different industries such as automotive, aviation, white goods manufacture, and panel building
- **Special specifications supplied by customers' order**
- Material: Polyamide 6,6, UL94V-2
- Color: Black

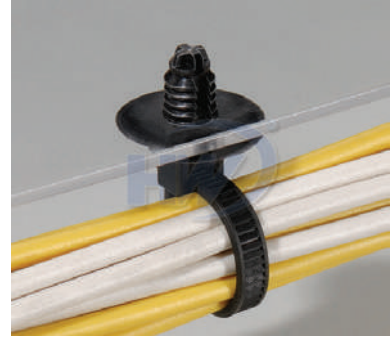

FTF-001

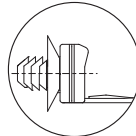
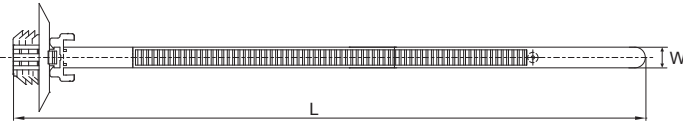

FTF-002

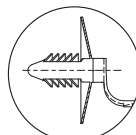
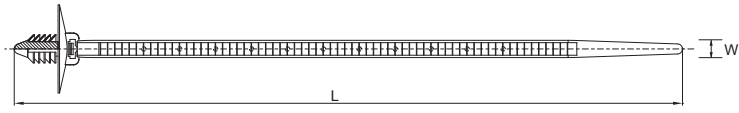

FTF-020, FTF-021

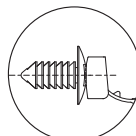
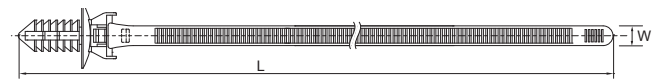

FTF-023

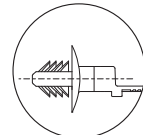
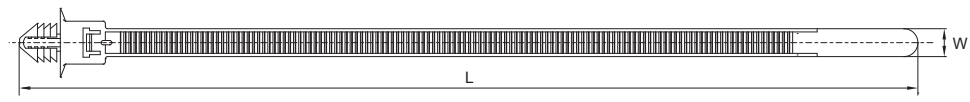

Part No.	Length (L) mm (inch)	Width (W) mm (inch)	Max.Bundle ϕ mm (inch)	Min. Loop Tensile Strength			Mounting Hole ϕ mm (inch)	Panel Thickness mm (inch)
				N	kgf	lbf		
FTF-001	153 (6.02)	5.0 (0.20)	36 (1.42)	178	18.2	40	7.0x13.0 (0.28x0.51)	0.8~1.5 (0.32~0.06)
FTF-002	186 (7.32)	4.8 (0.19)	42 (1.65)	133	13.6	30	ϕ 7.6 (0.30)	1.0~2.5 (0.04~0.10)
FTF-020	210 (8.25)	4.8 (0.19)	50 (1.97)	218	22.2	49	ϕ 7.3~7.8 (0.29~0.31)	6.0~8.0 (0.24~0.32)
FTF-021	113 (4.44)	4.8 (0.19)	25 (0.98)	218	22.2	49	ϕ 7.3~7.8 (0.29~0.31)	6.0~8.0 (0.24~0.32)
FTF-023	210 (8.25)	6.5 (0.26)	50 (1.97)	218	22.2	49	ϕ 9.0 (0.35)	1.0~2.8 (0.04~0.11)

CABLE TIES AND FIR-TREE MOUNT ASSEMBLIES

- Fir-tree mount assemblies applied with cable ties can adjust the position of bundle and convenient to fasten and insert
- Fir-tree design with disc can enhance the stable of fixing and avoid dust and water invasion
- Fir-tree push mount design applied to various thickness of board or one-side thread hole
- Applied to different industries such as automotive, aviation, white goods manufacture, and panel building
- **Special specifications supplied by customers' order**
- Material: Polyamide 6,6, UL94V-2
- Color: Black

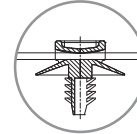
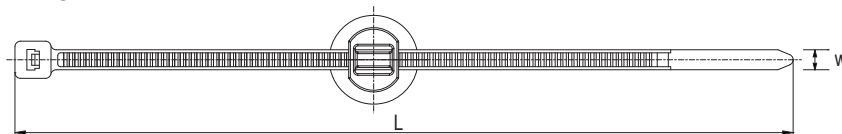

Part No.	Cable Ties Part No	Fir-Tree Mount Part No	Length (L) mm (inch)	Width (W) mm (inch)	Max.Bundle ϕ mm (inch)	Min. Loop Tensile Strength			Mounting Hole ϕ mm (inch)	Panel Thickness mm (inch)
						N	kgf	lbf		
FTF-017	GT-150I	FTM-5	150 (5.91)	3.6 (0.14)	35 (1.38)	178	18.2	40	ϕ 4.5 (0.18)	0.8~2.0 (0.03~0.08)
FTF-018	GT-140I	FTM-5	140 (5.51)	3.6 (0.14)	33 (1.30)	178	18.2	40	ϕ 4.5 (0.18)	0.8~2.0 (0.03~0.08)

PUSH-IN CABLE TIE MOUNTS

- Designed for maximum stability when securing cable bundles.
- The arrow head is utilized to form a secure anchor point for cable tie on a panel or chassis.
- Material: Polyamide 6.6, UL94V-2
- Color: Black

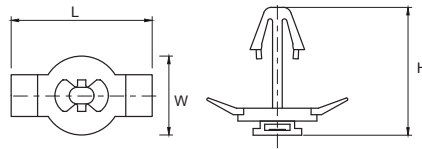

Part No.	Length (L) mm (inch)	Width (W) mm (inch)	Height (H) mm (inch)	Mounting Hole ϕ mm (inch)	Panel Thickness mm (inch)	Max. Tie Width mm (inch)
PTM-8S	32.0 (1.26)	30.4 (1.20)	20 (0.79)	12 (0.47)	8 (0.31)	7.9 (0.31)
PTM-8L	40.5 (1.59)	44.7 (1.76)	25 (0.98)	12 (0.47)	16 (0.63)	7.9 (0.31)

FIR-TREE MOUNT CABLE TIES

- Fir-tree push mount design applied to varied thickness of board or one-side thread hole
- The wing design of the mount helps stabilize the tie in high vibration applications
- Applied to different industries such as automotive, aviation, white goods manufacture, and panel building
- **Special specifications supplied by customers' order**
- Material: Polyamide 6,6, UL94V-2
- Color: Black

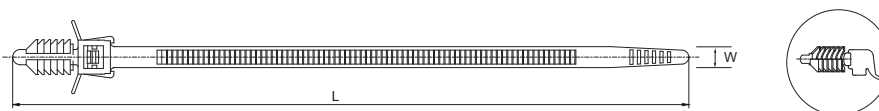

Part No.	Length (L) mm (inch)	Width (W) mm (inch)	Max.Bundle ϕ mm (inch)	Min. Loop Tensile Strength			Mounting Hole ϕ mm (inch)	Panel Thickness mm (inch)
				N	kgf	lbf		
FTF-008	155 (6.10)	4.8 (0.19)	35 (1.38)	133	13.6	30	ϕ 7.5~8.0 (0.30~0.32)	0.8~1.6 (0.03~0.06)

PUSH MOUNT CABLE TIES WITH DISC

Fastening System
Engineering Fasteners

- Push mount design with disc can enhance the stable of fixing and avoid dust and water invasion
- These ties are ideal for fixing bundles along a wide range of surfaces materials such as sheet metal, wood, or cast iron
- One-piece, all plastic ties for quick, simple cable mounting
- Applied to different industries such as automotive, aviation, white goods manufacture, and panel building
- **Special specifications supplied by customers' order**
- Material: Polyamide 6,6, UL94V-2
- Color: Black

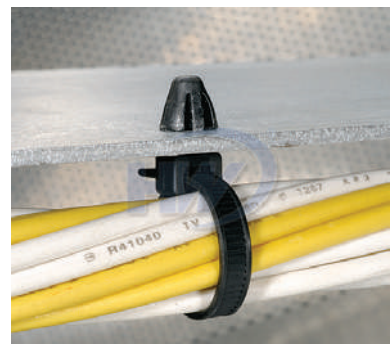

FTF-003

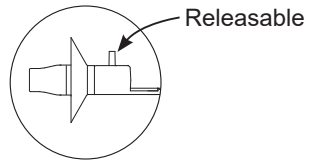
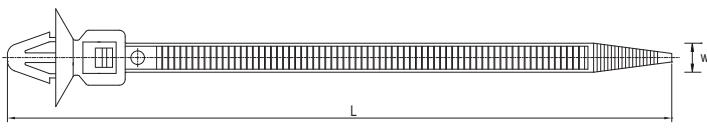

FTF-004

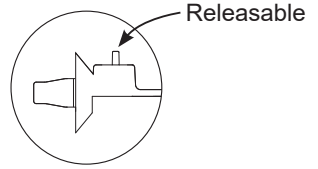
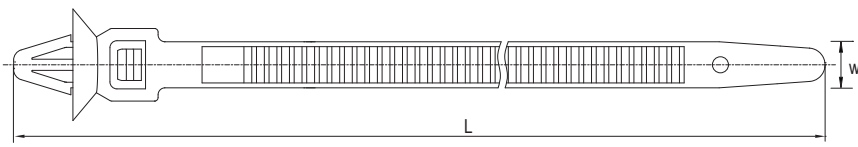

FTF-022

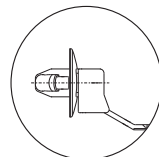
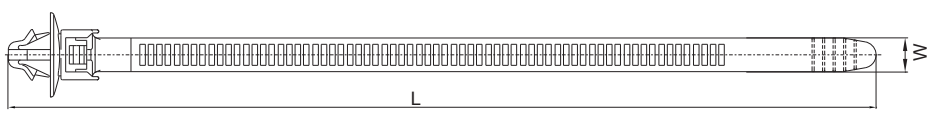

Part No.	Length (L) mm (inch)	Width (W) mm (inch)	Max.Bundle ϕ mm (inch)	Min. Loop Tensile Strength			Mounting Hole ϕ mm (inch)	Panel Thickness mm (inch)
				N	kgf	lbf		
FTF-003	110 (4.33)	4.8 (0.19)	22 (0.87)	133	13.6	30	ϕ 5.7 (0.22)	1.0~3.0 (0.04~0.12)
FTF-004	154 (6.06)	6.6 (0.26)	35 (1.38)	178	18.2	40	ϕ 5.8 (0.23)	1.0~3.0 (0.04~0.12)
FTF-022	165 (6.50)	6.4 (0.25)	35 (1.38)	392	40.0	88	ϕ 6.5 (0.26)	1.0~3.0 (0.04~0.12)

PUSH MOUNT CABLE TIES

- The wing design of the mount helps stabilize the tie in high vibration applications
- These ties are ideal for fixing bundles along a wide range of surfaces materials such as sheet metal, wood, or cast iron
- One-piece, all plastic ties for quick, simple cable mounting
- Applied to different industries such as automotive, aviation, white goods manufacture, and panel building
- **Special specifications supplied by customers' order**
- Material: Polyamide 6,6, UL94V-2
- Color: Black



Fastening System
Engineering Fasteners

FTC-010

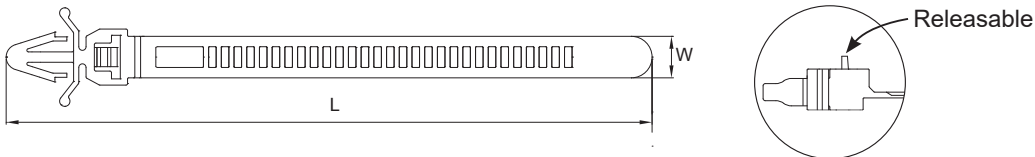

FTC-011

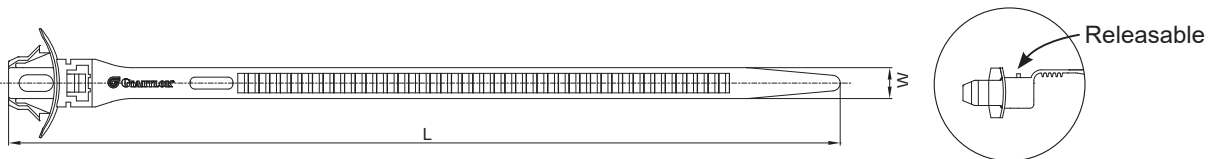

FTF-009

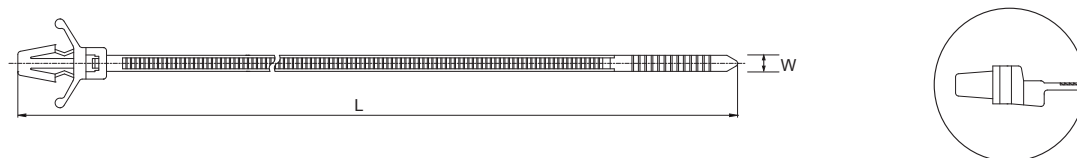

FTF-019

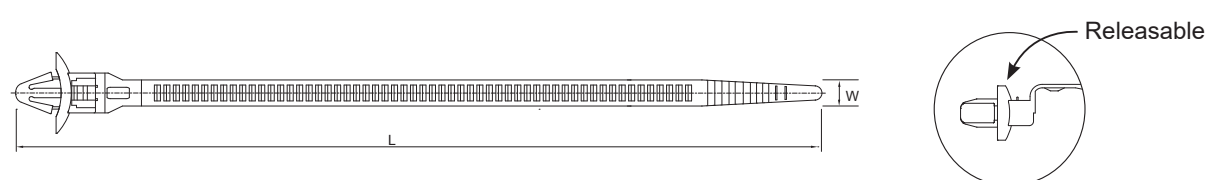

Part No.	Length (L) mm (inch)	Width (W) mm (inch)	Max.Bundle ϕ mm (inch)	Min. Loop Tensile Strength			Mounting Hole ϕ mm (inch)	Panel Thickness mm (inch)
				N	kgf	lbf		
FTC-010	125 (4.90)	8.0 (0.31)	26 (1.02)	222	22.6	50	ϕ 7.8 (0.31)	1.0~3.0 (0.04~0.12)
FTC-011	174 (6.86)	6.5 (0.26)	43 (1.69)	147	15	33	ϕ 12.7 (0.50)	1.0~2.5 (0.04~0.10)
FTF-009	112 (4.41)	2.5 (0.10)	22 (0.87)	80	8.2	18	ϕ 4.8 (0.19)	0.5~2.4 (0.02~0.09)
FTF-019	170 (6.69)	5.5 (0.22)	40 (1.57)	178	18.2	40	ϕ 6.5 (0.26)	1.0~2.8 (0.04~0.11)

WIRE COLLECT CABLE TIES

- L-preformed tie shape helps strapped object closer attach to fixing point, minimizing the space taken
- Outside serrated design ensures not causing damages to the bundle surface, especially in vibration environments
- Low insertion force is required
- Extra extended pawl helps release the ties quicker and easier while operating in restricted space of automobile
- Releasable design is ideal for the occasion where reinstallation is required
- Added width of cable tie offered a more secure fixing that the firm fasten is asked for
- **Special specifications supplied by customers' order**
- Material: Polyamide 6,6, UL94V-2
- Color: Black

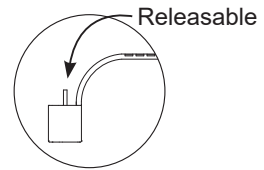
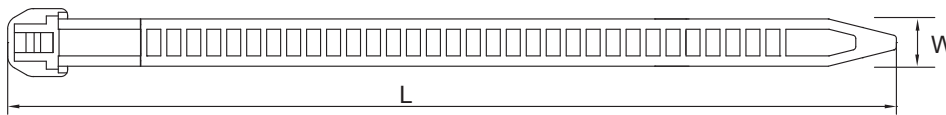

Part No.	Length (L) mm (inch)	Width (W) mm (inch)	Max.Bundle ø mm (inch)	Min. Loop Tensile Strength		
				N	kgf	lbf
FTT-004	134 (5.26)	7.1 (0.28)	33 (1.30)	392	40.0	88

CABLE TIES AND EDGE CLIPS

- Edge clips embedded with metal clamps keep cable maintain vertical, horizontal or any angle against boards
- Applicable for circumstances which drilled holes are not allowed to, or high temperature environments which adhesive fasteners cannot fix on
- Applied to different industries such as automotive industry, wire harness, electrical and panel building
- **Special specifications supplied by customers' order**
- Material: Polyamide 6,6, UL94V-2 (plastic body). Galvanized steel (teeth)
- Color: Black



FTC-001

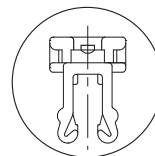
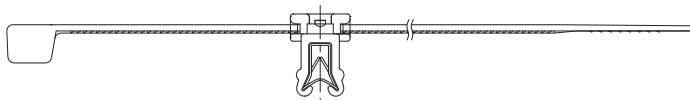

FTC-002

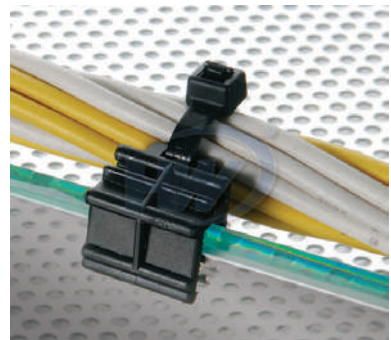
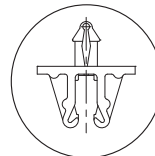
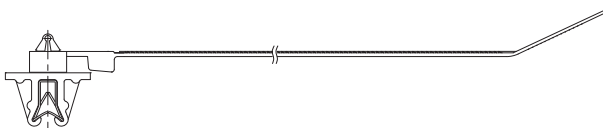

Part No.	Cable Ties Part No	Length (L) mm (inch)	Width (W) mm (inch)	Max.Bundle ø mm (inch)	Min. Loop Tensile Strength			Panel Thickness mm (inch)
					N	kgf	lbf	
FTC-001	GTPG-200STB	200 (7.87)	4.8 (0.19)	50 (1.97)	218	22.2	49	0.8~2.0 (0.03~0.08)
FTC-002	GTM-150IB	150 (5.91)	3.6 (0.14)	32 (1.26)	80	8.2	18	1.0~4.8 (0.04~0.19)

CABLE FIXING ACCESSORIES TAPE CLIPS

- Tape clips can inserted and fixed to pre-drilled holes on various metal board
- The tape support applied with cable ties or adhesive tape to fixed the bundles on both sides
- Push mount with disc can enhance the stable of fixing
- Fir-tree push mount provides more secure and reliable fixing especially for movable and vibratile tools or machine
- Especially designed for the automotive industry by offering simple and secure way for fixing cables or pipes
- **Special specifications supplied by customers' order**
- Material: Polyamide 6,6, UL94V-2
- Color: Black

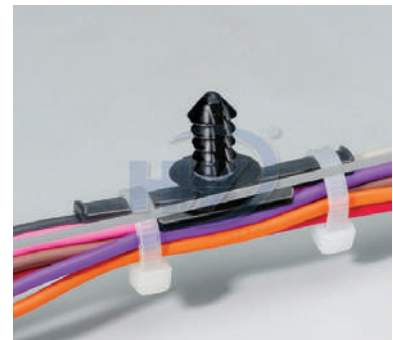

Fastening System
Engineering Fasteners

FTF-005

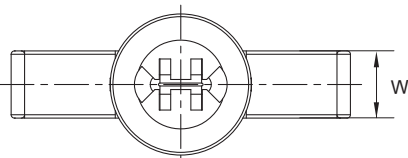
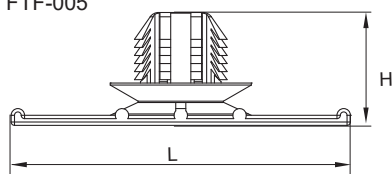

FTF-006

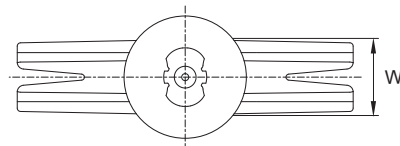
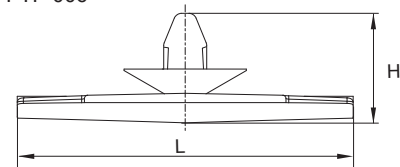

FTF-007

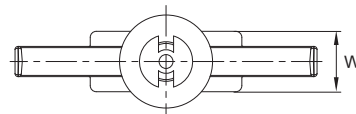
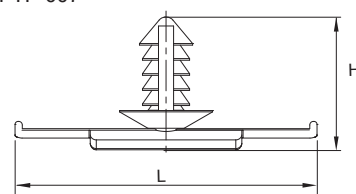

Part No.	Length (L) mm (inch)	Width (W) mm (inch)	Height (H) mm (inch)	Mounting Hole ϕ mm (inch)	Panel Thickness mm (inch)
FTF-005	50 (1.97)	10.0 (0.39)	16.8 (0.66)	7.6x13.8 (0.30x0.54)	0.8~2.2 (0.32~0.09)
FTF-006	50 (1.97)	11.2 (0.44)	16.3 (0.64)	ϕ 6.4 (2.25)	0.8~2.2 (0.32~0.09)
FTF-007	50 (1.97)	10.0 (0.39)	22.0 (0.87)	ϕ 7.8 (0.31)	1.0 (0.04)

AUTOMATIC HARNESS CLIPS

- Bundle can be fastened in the clips without cable ties
- Wide and hard to release mount design provides secure protection and insulation for cables
- Applying by first drilling a hole on panel or board with appropriate hole diameter and board thickness, then inserting the mount head to the hole for fixture
- Push mount design with disc can enhance the stable of fixing
- **Special specifications supplied by customers' order**
- Material: Polyamide 6,6, UL94V-2
- Color: Black

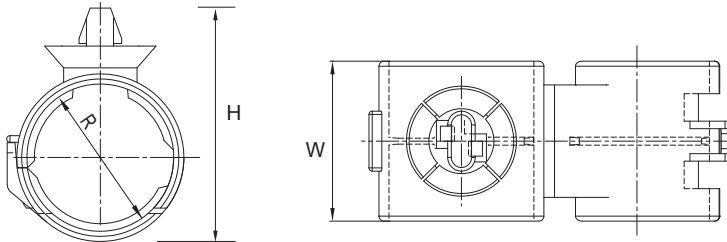

Part No.	Width (W) mm (inch)	Height (H) mm (inch)	Max.Bundle ϕ mm (inch)	Mounting Hole ϕ mm (inch)	Panel Thickness mm (inch)
FHC-001	32.0 (1.26)	46.0 (1.81)	29.0 (1.14)	ϕ 8.4 (0.33)	1.0~4.5 (0.04~0.18)
FHC-002	32.0 (1.26)	53.5 (2.11)	37.0 (1.46)	ϕ 8.6 (0.34)	1.0~4.8 (0.04~0.19)

AUTOMATIC HARNESS HOSE CLIPS

- Fix the clip with screw on the board
- Circular clips are hard to release to secure the pipe or cables
- Reed design fits different size of pipes
- **Special specifications supplied by customers' order**
- Material: Polyamide 6,6, UL94V-2
- Color: Black

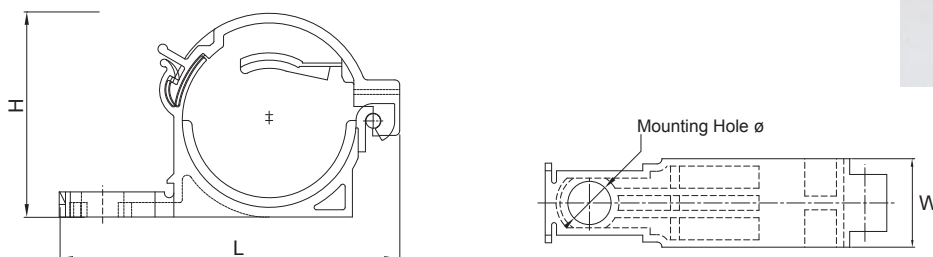

Part No.	Length (L) mm (inch)	Width (W) mm (inch)	Height (H) mm (inch)	Mounting Hole ϕ mm (inch)	Max. Bundle ϕ mm (inch)
FHC-003	70.6 (2.78)	18 (0.71)	42.2 (1.66)	ϕ 8.8 (0.35)	30 (1.18)

CABLE TIE TOOLS



GIT-701

- For tensioning and cutting off cable tie with width from 2.4~4.8 mm (0.09~0.19 inch)
- Dimension: 160x70x20 mm (6.30x2.76x0.79 inch)
- Net weight: 51 g (0.11 lbs)
- Main material: Plastic



GIT-702P

- For fast, safe tensioning and cutting off cable tie with width from 2.4~4.8 mm (0.09~0.19 inch), thickness up to 1.6 mm (0.06 inch)
- Dimension: 165x135x20 mm (6.50x5.31x0.79 inch)
- Net weight: 210 g (0.46 lbs)
- Main material: Plastic



GIT-702M

- For fast, safe tensioning and cutting off cable tie with width from 2.2~4.8 mm (0.09~0.19 inch), thickness up to 1.6 mm (0.06 inch)
- Dimension: 165x125x20 mm (6.50x4.92x0.79 inch)
- Net weight: 300 g (0.66 lbs)
- Main material: Metal



GIT-704G

- For cable tie of width 3.6~10.6 mm (0.14~0.42 inch) and thickness 1.2~2.3 mm (0.05~0.09 inch)
- Dimension: 200x100x20 mm (7.87x3.94x0.79 inch)
- Net weight: 310 g (0.68 lbs)
- Main material: Metal



GIT-709

- For cable tie of width 3.6~10.6 mm (0.14~0.42 inch) and thickness 1.2~2.3 mm (0.05~0.09 inch)
- Dimension: 210x115x22 mm (8.27x4.53x0.87 inch)
- Net weight: 367g (0.808 lbs)
- Main material: Metal

BANDING TOOLS



GIT-705

- For stainless steel ties of width up to 7.9 mm (0.31 inch) and thickness up to 0.3 mm (0.01 inch)
- Single handle operation for fast installation, with controlled and adjustable tension
- Dimension: 178x140x29 mm (7.01x5.51x1.14 inch)
- Net weight: 560 g (1.23 lbs)
- Main material: Metal



GIT-2065

- For stainless steel ties of width up to 12 mm (0.47 inch) and thickness up to 0.3 mm (0.01 inch)
- Semi-auto module enables the function of tightening and cutting off the strip
- Dimension: 210x120x40mm (8.27x4.72x1.57 inch)
- Net weight: 550 g (1.21 lbs)
- Main material: Metal



GIT-260

- For stainless steel strapping of width 9.5~19.0 mm (0.37~0.75 inch) and of thickness up to 0.76 mm (0.03 inch)
- Screw drive tension mechanism with cutter and hammer knob provides high tension with minimal effort
- Dimension: 260x200x78 mm (10.24x7.87x3.07 inch)
- Net weight: 1,870 g (4.11 lbs)
- Main material: Metal

ECM-TYPE CABLE MARKERS

- Soft PVC, concave conversed shape, number code in sleeve elasticity of in-diameter
- Usage: Peel each hack lightly
- Feature :Suitable any size, special length and marking is available to order
- Material: Soft PVC

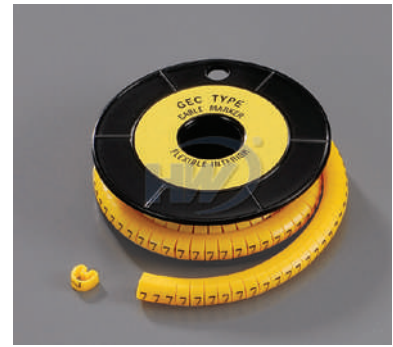
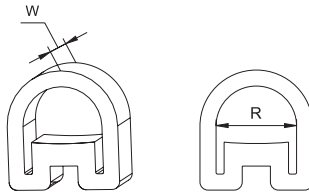

Part No.	Suitable Wire		Inside ϕ (R)	Width (W)	Standard Markings
	sq. mm	AWG			
GEC-0	0.75 ~ 1.25	18 ~ 16	2.0-3.2	3.5	0~9,A~Z,+,-,/
GEC-1	0.75 ~ 3.0	18 ~ 12	3.0-5.2	4.0	0~9,A~Z,+,-,/
GEC-2	3.5 ~ 8.0	12 ~ 8	3.6-7.4	5.0	0~9,A~Z,+,-,/
GEC-3	8.0 ~ 22.0	8 ~ 4	5.2-10.0	5.5	0~9,A~Z,+,-,/

FLAT CABLE MARKERS

- With its unique oval shape design provides:
 - 1.Slip over cable directly (for small cable)
 - 2.Slip onto marker strip (for large cable or cable bundles)
- Material: Soft PVC, elasticity of in-diameter

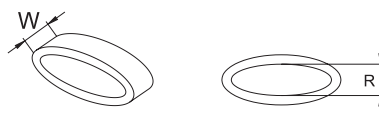

Part No.	Suitable Wire		Inside ϕ (R)	Width (W)	Standard Markings
	sq. mm	AWG			
OFM-1	2.0 ~ 8.0	14 ~ 8	3.5~7.0	5.0	0~9,A~Z,+,-,/

OM-TYPE CABLE MARKERS

- Construction: Number code printed in width 10mm
- Feature: Provide wire marking, install easily and insulation
- Material: Soft PVC, flexible, transfigure hardly

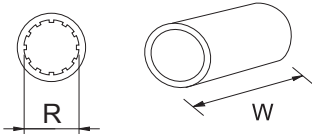

Part No.	Suitable Wire		Inside \varnothing (R)	Width (W)	Standard Markings
	sq. mm	AWG			
GOM-0.75	0.75	18	3.0	10	0~9,A~Z,+,-,/
GOM-1.25	1.25	16	3.2	10	0~9,A~Z,+,-,/
GOM-2.0	2.00	14	3.6	10	0~9,A~Z,+,-,/
GOM-3.5	3.50	12	4.2	10	0~9,A~Z,+,-,/
GOM-5.5	5.50	10	5.1	10	0~9,A~Z,+,-,/
GOM-8.0	8.00	8	6.2	10	0~9,A~Z,+,-,/

INTRODUCTION OF HUA WEI'S FASTENERS

Hua Wei's fasteners provide multiple fixing method such as self adhesive, screw on, push mount, and steel nail. Self adhesive type is suitable for boards which can not or are unsuitable to drill holes. Screw on type offers safe and secured fixture and is suitable for larger and heavier wire bundles. Push mount type can be fixed efficiently and simply to push into pre-drilled holes. Cable clips can be used with steel nail to knock into the walls or floors, especially solid concrete ones. Cable clips can be fixed permanently on vertical walls and stay secure. The double nails make the object more secured and safe.

These fixing method offer the most efficient solution of fixture and arrangement, and separate the bundles from the boards- especially the metal board- to avoid electrical short-cut or abrasion which may cause wire damaged.

Cable clamps, applied with cable ties, can adjust the bundle diameter of cable ties to fit the size of wire bundle and achieve completely fastened. One piece clamps can save accessories of arrangement and fixture. From small cable clamps to saddle wire holders which can accommodate several wire bundles, the one piece clamps can finish the arrangement only to place or push the bundle into the wire holders with high efficiency. Cable clips offer full product line and you find best wire

arrangement solution from small strand of wire to large cables, tubes or hoses.

Wall plugs are the new product line of Hua Wei, and suitable for fixing electrical control boxes, cabinets and valued art pieces on walls. Its special spread-free design prevents damage of tiles and plasters, and offers the most secured fixture.

PCB supports are specially design to separate the printed circuit board(PCB) by its varied shape and height to apply to variable applications. Dual locking type (push mount head at two ends) can separate and fix two printed circuit boards at one time. Single locking type (push mount head at one end) is suitable for separate two different design of printed circuit board. Furthermore, other methods, such as push mount plus with adhesive tape and push mount with screw on, enhance the stability and applications of PCB supports.

Polyamide screw series are made from premium polyamide compound, which carry with excellent chemical resistance. The multiple types and full range of dimensions satisfy all kinds of application. The features of insulation, light weight, and high precision are excellent choices for electronic equipment, medical equipment, toys industry, etc.

Fastening System
Fasteners

Information and installation instructions for self adhesive mounting bases

Hua Wei provides two ways of tie mounts: one is screw mount and another is self adhesive mount. This enables a permanent fixing lasting months or even years. To use these adhesives, the surface must be dry, and free of dust, oil, oxides, parting agents and other impurities. After cleaning, it allows the surface to dry completely. Peel off the protective backing on the self adhesive base, ensuring the adhesive is not touched. Apply the part to the surface and press down firmly for several seconds.

Instructions for use

1. The surface must be dry, free from dust, oil, oxides, parting agents and other impurities. When using other appropriate cleaning agents, ensure that they do not attack the surface or leave any residues.
2. After cleaning, it allows the surface to dry completely.
3. Peel off protective backing and ensure the adhesive area is not touched.
4. Press down firmly on the base for several seconds.
5. Depending on the type of adhesive, wait for several minutes or hours so that the adhesive can bond completely with the surface.

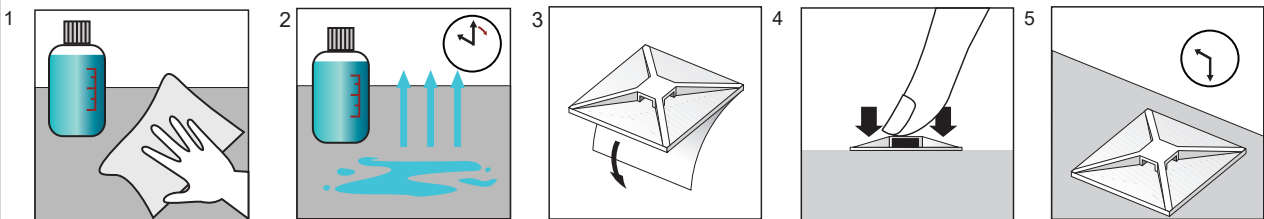

MATERIAL & APPLICATION TABLE

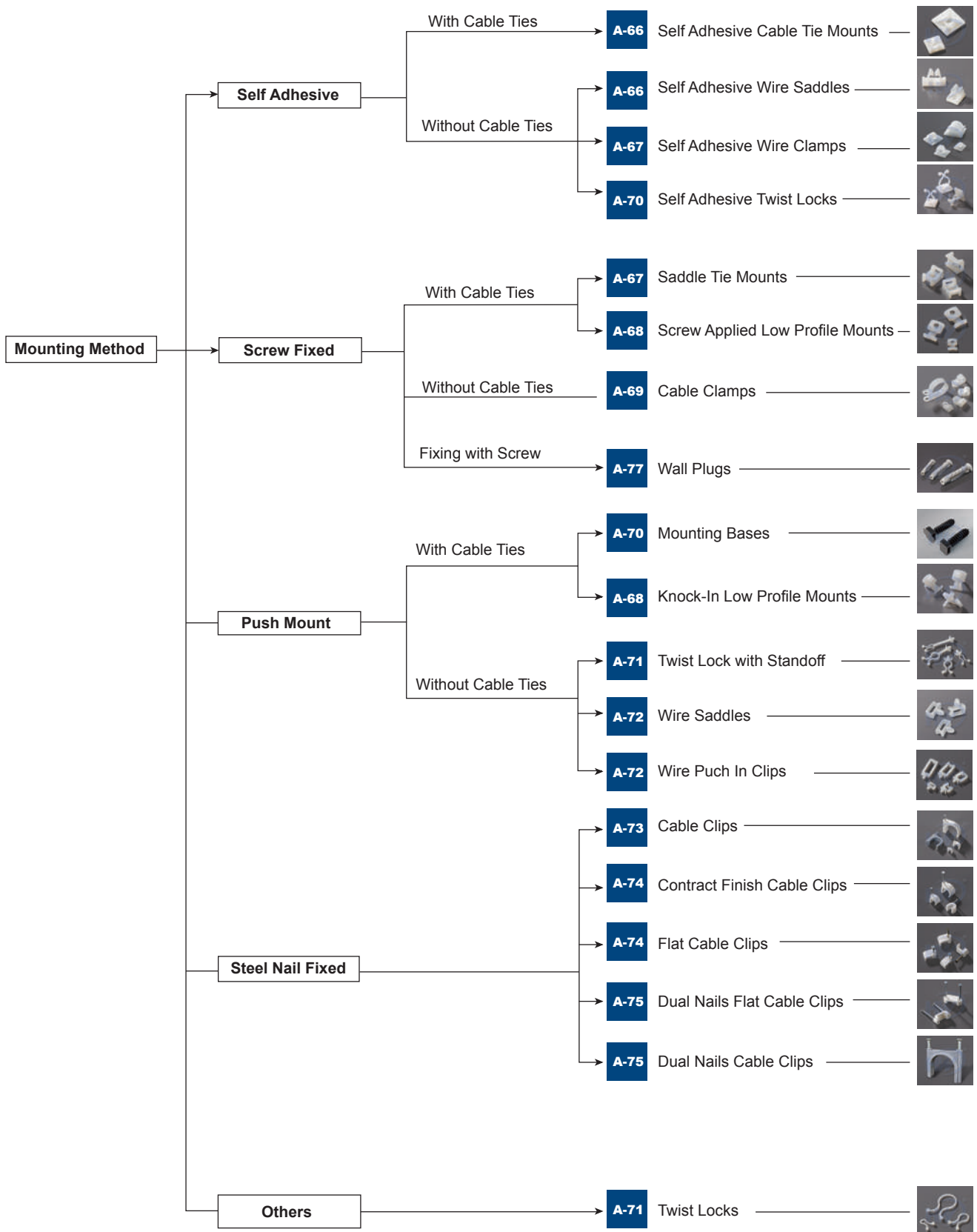

Fastening System
Fasteners

MATERIAL & APPLICATION TABLE

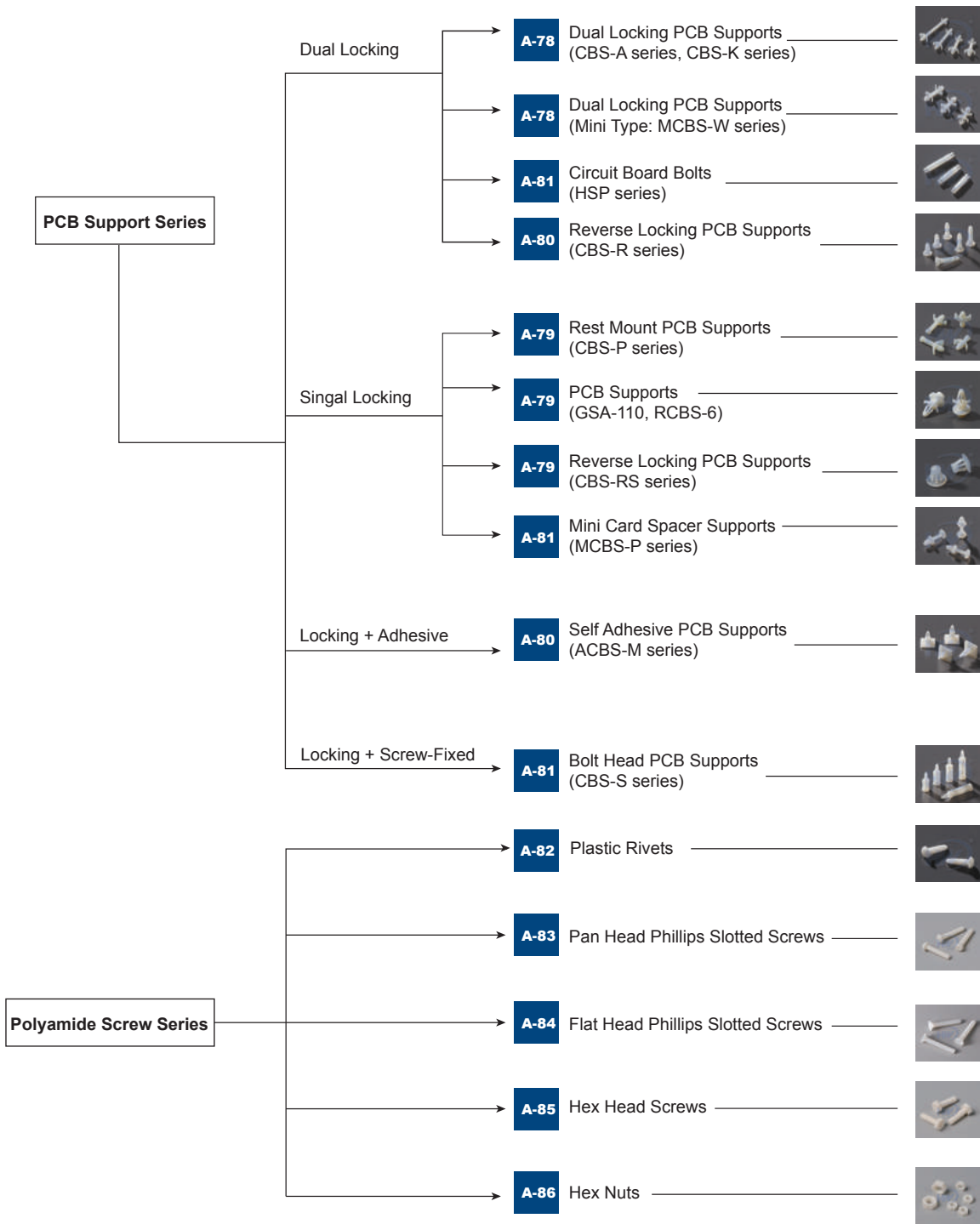

MATERIAL & APPLICATION TABLE

Product Name	Self Adhesive Cable Tie Mounts	Self Adhesive Wire Saddles	Self Adhesive Wire Clamps	Saddle Tie Mounts
Type	HW	HW	HW	TM
Page	A-66	A-66	A-67	A-67
Material	Polyamide 6,6	Polyamide 6,6	Polyamide 6,6	Polyamide 6,6
Operating Temperature				
Max.	85°C (185°F)	85°C (185°F)	85°C (185°F)	85°C (185°F)
Min.	-40°C (-40°F)	-40°C (-40°F)	-40°C (-40°F)	-40°C (-40°F)
Resistant Properties				
UV light/ozone	△	△	△	△
Oils and greases	◎	◎	◎	◎
Solvents	○	○	○	○
Petrol	◎	◎	◎	◎
Flammability	UL94V-2	UL94V-2	UL94V-2	UL94V-2
Possible Applications				
Switch cabinets	★	★	★	★
Electronics	★	★	★	
Aerospace industries	★	★	★	★
Turbines and engines				
Telecommunications	★	★	★	★
Ship-building/Marine	★	★	★	★
Military industry				
Harnessmakers				
Public buildings	★	★	★	★
Automotives industries	★	★	★	★
Sample Applications				
Bundling of cables and wires	★	☆	☆	★
Bundling of hoses	★			★
Welded or threaded studs				
Drilled hole with thread	★	★	★	★
Edge fastening on steel plated				
Blind holes in sheet metal				
Fixing with self adhesive base	★	★	★	
Bundling of optical cables				
Fastening optical cables	★	☆	☆	★
For restricted space	☆	☆	☆	☆
Fastening bellows				
Parallel wires	☆			☆
Post-installation fastening	★	★	★	★
Temporary fastening		☆	☆	
For thin, sensitive insulation				
Underwater use				
Identification of bundles				

◎ Excellent ○ Good △ Medium ★ Suitable ☆ Partly Suitable

MATERIAL & APPLICATION TABLE

Product Name	Knock-In Low Profile Mounts	Screw Applied Low Profile Mounts	Cable Clamps	Mounting Bases
Type	KM	SM	GCL	TH
Page	A-68	A-68	A-69	A-70
Material	Polyamide 6,6	Polyamide 6,6	Polyamide 6,6	Polyamide 6,6
Operating Temperature				
Max.	85°C (185°F)	85°C (185°F)	85°C (185°F)	85°C (185°F)
Min.	-40°C (-40°F)	-40°C (-40°F)	-40°C (-40°F)	-40°C (-40°F)
Resistant Properties				
UV light/ozone	△	△	△	△
Oils and greases	◎	◎	◎	◎
Solvents	○	○	○	○
Petrol	◎	◎	◎	◎
Flammability	UL94V-2	UL94V-2	UL94V-2	UL94V-2
Possible Applications				
Switch cabinets		★	☆	★
Electronics		★	☆	
Aerospace industries	★	★	★	★
Turbines and engines				
Telecommunications	☆	★	☆	
Ship-building/Marine	★	★	★	
Military industry				
Harnessmakers				
Public buildings		★	★	★
Automotives industries		★		
Sample Applications				
Bundling of cables and wires	★	★	★	
Bundling of hoses	★	★	★	
Welded or threaded studs		★	★	
Drilled hole with thread	★	★	★	★
Edge fastening on steel plated				
Blind holes in sheet metal				
Fixing with self adhesive base				
Bundling of optical cables				
Fastening optical cables	★	★		
For restricted space		★		
Fastening bellows				
Parallel wires		★		
Post-installation fastening		★	★	
Temporary fastening				
For thin, sensitive insulation				
Underwater use				
Identification of bundles				

◎ Excellent ○ Good △ Medium ★ Suitable ☆ Partly Suitable

Product Name	Self Adhesive Twist Locks	Twist Locks	Twist Lock with Standoff	Wire Push In Clips	Wire Saddles
Type	HW	TH	TH	CH, SH, SQ	WH
Page	A-70	A-71	A-71	A-72	A-72
Material	Polyamide 6,6	Polyamide 6,6	Polyamide 6,6	Polyamide 6,6	Polyamide 6,6
Operating Temperature					
Max.	85°C (185°F)	85°C (185°F)	85°C (185°F)	85°C (185°F)	85°C (185°F)
Min.	-40°C (-40°F)	-40°C (-40°F)	-40°C (-40°F)	-40°C (-40°F)	-40°C (-40°F)
Resistant Properties					
UV light/ozone	△	△	△	△	△
Oils and greases	◎	◎	◎	◎	◎
Solvents	○	○	○	○	○
Petrol	◎	◎	◎	◎	◎
Flammability	UL94V-2	UL94V-2	UL94V-2	UL94V-2	UL94V-2
Possible Applications					
Switch cabinets	★	★	★	★	★
Electronics	★	★	★	★	★
Aerospace industries	★	★	★	★	★
Turbines and engines					
Telecommunications	★	★	★	★	★
Ship-building/Marine	★	★	★	★	★
Military industry			★		
Harnessmakers			★		
Public buildings	★	★	★	★	★
Automotives industries	★	★	★	☆	☆
Sample Applications					
Bundling of cables and wires	★	★	★	★	★
Bundling of hoses			★		
Welded or threaded studs					
Drilled hole with thread			★	★	★
Edge fastening on steel plated					
Blind holes in sheet metal					
Fixing with self adhesive base	★				
Bundling of optical cables		★	★	★	★
Fastening optical cables		★		★	★
For restricted space	★	★	★		
Fastening bellows					
Parallel wires			★		
Post-installation fastening					
Temporary fastening		★			
For thin, sensitive insulation				★	★
Underwater use					
Identification of bundles					

◎ Excellent ○ Good △ Medium ★ Suitable ☆ Partly Suitable

MATERIAL & APPLICATION TABLE

Product Name	Cable Clip	Contract Finish Cable Clips	Flat Cable Clips	Dual Nails Flat Cable Clips	Dual Nails Cable Clips	Wall Plugs
Type	GC, GCR	GB	GF, GFC	GNF	GNC	WA
Page	A-73	A-74	A-74	A-75	A-75	A-77
Material	PE	PE	PE	PE	PE	Polyamide 6
Operating Temperature						
Max.	80°C (176°F)	80°C (176°F)	80°C (176°F)	80°C (176°F)	80°C (176°F)	85°C (185°F)
Min.	-40°C (-40°F)	-40°C (-40°F)	-40°C (-40°F)	-40°C (-40°F)	-40°C (-40°F)	-40°C (-40°F)
Resistant Properties						
UV light/ozone	△	△	△	△	△	○
Oils and greases	◎	◎	◎	◎	◎	○
Solvents	○	○	○	○	○	○
Petrol	○	○	○	○	○	○
Flammability	--	--	--	--	--	UL94V-2
Possible Applications						
Switch cabinets	★	★	★	★		
Electronics	★	★	★	★		
Aerospace industries						
Turbines and engines						
Telecommunications	★	★	★	★	★	
Ship-building/Marine						
Military industry						
Harnessmakers	★	★	★			
Public buildings	★	★	★	★	★	★
Automotives industries						
Household Appliance						★
Toy Industry						
Medical Equipment						
Sample Applications						
Bundling of cables and wires						
Bundling of hoses	★					
Welded or threaded studs						
Drilled hole with thread						
Predrilled holes						★
Edge fastening on steel plated						
Blind holes in sheet metal						
Fixing with self adhesive base						
Bundling of optical cables						
Fastening optical cables	★	★	★	★	★	
Fastening pipes / tubes	★				★	
Fastening cooler pipe						
For restricted space	★	★	★			
Parallel wires						
Fastening identification plates						
For heavy duty fastening						★

◎ Excellent ○ Good △ Medium ★ Suitable ☆ Partly Suitable

Product Name	Dual Locking PCB Supports	Dual Locking PCB Supports	Rest Mount PCB Supports	PCB Supports	Reverse Locking PCB Supports
Type	CBS-A, CBS-K	MCBS-W	CBS-P	GSA-110, RCBS-6	CBS-RS
Page	A-78	A-78	A-79	A-79	A-79
Material	Polyamide 6,6	Polyamide 6,6	Polyamide 6,6	Polyamide 6,6	Polyamide 6,6
Operating Temperature					
Max.	85°C (185°F)	85°C (185°F)	85°C (185°F)	85°C (185°F)	85°C (185°F)
Min.	-40°C (-40°F)	-40°C (-40°F)	-40°C (-40°F)	-40°C (-40°F)	-40°C (-40°F)
Resistant Properties					
UV light/ozone	△	△	△	△	△
Oils and greases	◎	◎	◎	◎	◎
Solvents	○	○	○	○	○
Petrol	◎	◎	◎	◎	◎
Flammability	UL94V-2	UL94V-2	UL94V-2	UL94V-2	UL94V-2
Possible Applications					
Switch cabinets	★	★	★	★	★
Electronics	★	★	★	★	★
Aerospace industries	★	★	★	★	★
Turbines and engines	★	★	★	★	★
Telecommunications	★	★	★	★	★
Ship-building/Marine	★	★	★	★	★
Military industry	★	★	★		★
Harnessmakers					
Public buildings					
Automotives industries				★	★
Sample Applications					
Bundling of cables and wires					
Bundling of hoses					
Welded or threaded studs					
Drilled hole with thread	★	★	★	★	★
Edge fastening on steel plated					
Blind holes in sheet metal					
Fixing with self adhesive base					
Bundling of optical cables					
Fastening optical cables					
For restricted space	☆	☆	☆	☆	★
Fastening bellows					
Parallel wires					
Post-installation fastening					
Temporary fastening					
For thin, sensitive insulation					
Underwater use					
Identification of bundles					

◎ Excellent ○ Good △ Medium ★ Suitable ☆ Partly Suitable

MATERIAL & APPLICATION TABLE

Product Name	Reverse Locking PCB Supports	Self Adhesive PCB Supports	Bolt Head PCB Supports	Mini Card Spacer Supports	Circuit Board Bolts	Plastic Rivets
Type	CBS-R	ACBS-M	CBS-S	MCBS-P	HSP-N	R-1
Page	A-80	A-80	A-81	A-81	A-81	A-82
Material	Polyamide 6,6	Polyamide 6,6	Polyamide 6,6	Polyamide 6,6	Polyamide 6,6	Polyamide 6,6
Operating Temperature						
Max.	85°C (185°F)	85°C (185°F)	85°C (185°F)	85°C (185°F)	85°C (185°F)	85°C (185°F)
Min.	-40°C (-40°F)	-40°C (-40°F)	-40°C (-40°F)	-40°C (-40°F)	-40°C (-40°F)	-40°C (-40°F)
Resistant Properties						
UV light/ozone	△	△	△	△	△	△
Oils and greases	◎	◎	◎	◎	◎	◎
Solvents	○	○	○	○	○	○
Petrol	◎	◎	◎	◎	◎	◎
Flammability	UL94V-2	UL94V-2	UL94V-2	UL94V-2	UL94V-2	UL94V-2
Possible Applications						
Switch cabinets	★	★	★	★	★	★
Electronics	★	★	★	★	★	★
Aerospace industries	★	★	★	★	★	★
Turbines and engines	★	★	★	★	★	★
Telecommunications	★	★	★	★	★	★
Ship-building/Marine	★	★	★	★	★	★
Military industry	★	★	★	★	★	★
Harnessmakers						
Public buildings						
Automotives industries	★					
Sample Applications						
Bundling of cables and wires						
Bundling of hoses						
Welded or threaded studs						
Drilled hole with thread	★	★	★	★	★	★
Edge fastening on steel plated						
Blind holes in sheet metal						
Fixing with self adhesive base		★				
Bundling of optical cables						
Fastening optical cables						
For restricted space	★	☆	☆	☆	☆	☆
Fastening bellows						★
Parallel wires						
Post-installation fastening						
Temporary fastening						
For thin, sensitive insulation						
Underwater use						
Identification of bundles						

◎ Excellent ○ Good △ Medium ★ Suitable ☆ Partly Suitable

Product Name	Cord Grips	Cord Grips	Pan Head Phillips Slotted Screws	Flat Head Phillips Slotted Screws	Hex Head Screws	Hex Nuts
Type	5100/7	FP-7A	NS	NS	NS	NU
Page	A-82	A-82	A-83	A-84	A-85	A-86
Material	Polyamide 6,6+GF	Polyamide 6,6+GF	Polyamide 6,6	Polyamide 6,6	Polyamide 6,6	Polyamide 6,6
Operating Temperature						
Max.	85°C (185°F)	85°C (185°F)	85°C (185°F)	85°C (185°F)	85°C (185°F)	85°C (185°F)
Min.	-40°C (-40°F)	-40°C (-40°F)	-40°C (-40°F)	-40°C (-40°F)	-40°C (-40°F)	-40°C (-40°F)
Resistant Properties						
UV light/ozone	△	△	△	△	△	△
Oils and greases	◎	◎	◎	◎	◎	◎
Solvents	○	○	○	○	○	○
Petrol	◎	◎	◎	◎	◎	◎
Flammability	UL94V-2	UL94V-2	UL94HB	UL94HB	UL94HB	UL94HB
Possible Applications						
Switch cabinets	★	★	★	★	★	★
Electronics	★	★	★	★	★	★
Aerospace industries	★	★				
Turbines and engines	★	★				
Telecommunications	★	★	★	★	★	★
Ship-building/Marine	★	★				
Military industry	★	★				
Harnessmakers						
Public buildings						
Automotives industries	★	★				
Household appliance			★	★	★	★
Toy industry			★	★	★	★
Medical equipment			★	★	★	★
Sample Applications						
Bundling of cables and wires						
Bundling of hoses						
Welded or threaded studs			★	★	★	★
Drilled hole with thread			★	★	★	★
Predrilled holes			★	★	★	★
Edge fastening on steel plated						
Blind holes in sheet metal						
Fixing with self adhesive base						
Bundling of optical cables						
Fastening optical cables	★	★				
For restricted space						
Fastening bellows						
For thin, sensitive insulation			☆	☆	☆	☆
Fastening identification plates						
For heavy duty fastening						

◎ Excellent ○ Good △ Medium ★ Suitable ☆ Partly Suitable

SELF ADHESIVE CABLE TIE MOUNTS

- Available in either "screw mount" or "self adhesive mounting"
- Simple to install with a screw or bolt, the tie mounts give excellent security, particularly in areas of high vibration
- Designed to offer the maximum surface area, and in conjunction with the specially developed adhesive ensures that a very high pull-off force is achieved
- The tie mounts offer a '4-way' entry for the cable tie enabling quicker and more flexible installation
- Designed specifically for holding heavier cable bundles
- Material: Polyamide 6,6, UL94V-2
- Color: Natural, black

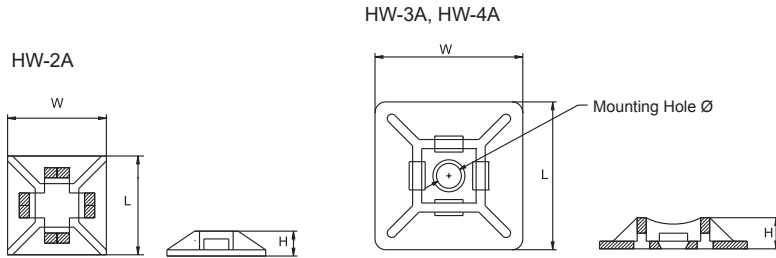

Part No.	Length (L) mm (inch)	Width (W) mm (inch)	Height (H) mm (inch)	Mounting Hole ϕ mm (inch)	Max. Tie Width mm (inch)
HW-2A	12.7 (0.50)	12.7 (0.50)	3.2 (0.13)	--	3.2 (0.13)
HW-3A	19.0 (0.75)	19.0 (0.75)	4.4 (0.17)	3.5 (0.14)	4.0 (0.16)
HW-4A	27.8 (1.09)	27.8 (1.09)	5.7 (0.22)	5.7 (0.22)	5.3 (0.21)

SELF ADHESIVE WIRE SADDLES

- Easy mounting with adhesive tape
- HW-6A is able to fastened by screw to secure the fixture
- Material: Polyamide 6,6, UL94V-2
- Color: Natural

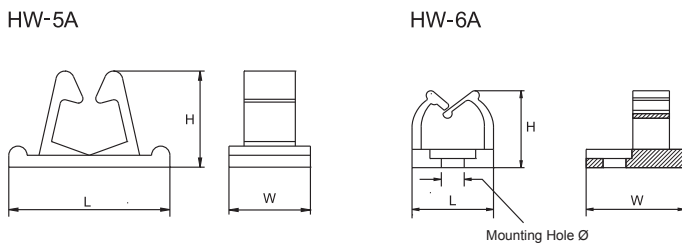

Part No.	Length (L) mm (inch)	Width (W) mm (inch)	Height (H) mm (inch)	Mounting Hole ϕ mm (inch)	Max. Bundle ϕ mm (inch)
HW-5A	17.6 (0.69)	8.9 (0.35)	10.5 (0.41)	--	8.4 (0.33)
HW-6A	8.8 (0.35)	10.8 (0.43)	8.4 (0.33)	2.5 (0.10)	5.0 (0.20)

SELF ADHESIVE WIRE CLAMPS

- Wires, cables or hoses can be quickly and easily installed using these one piece fixing clips
- These clips are ideal for use in applications which are difficult to access, or for areas where self adhesive is the only possible fixing method (for example where fixing 'hole' would be unacceptable)
- Material: Polyamide 6,6, UL94V-2
- Color: Natural

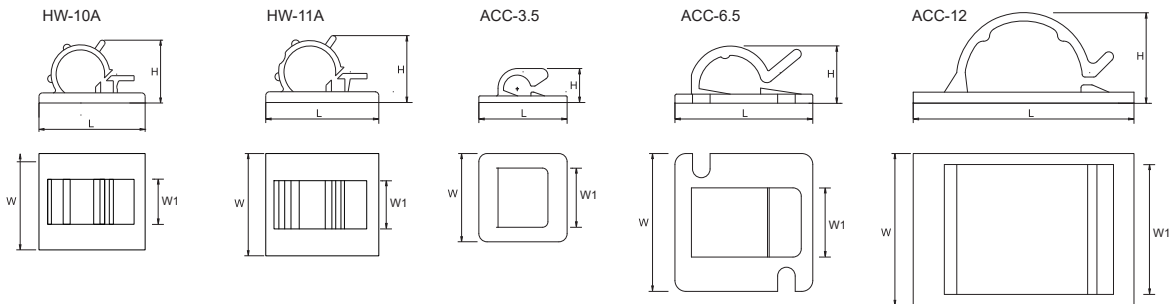
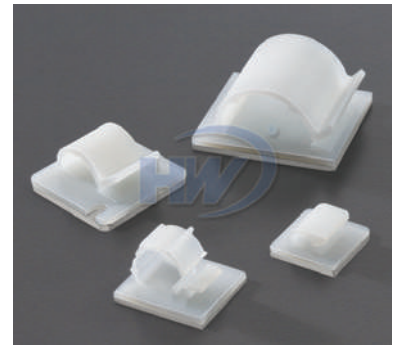

Part No.	L mm (inch)	W mm (inch)	W1 mm (inch)	H mm (inch)	Max.Bundle ø mm (inch)
HW-10A	21.5 (0.85)	17.0 (0.67)	12.0 (0.47)	15.0 (0.59)	11.0 (0.43)
HW-11A	21.5 (0.85)	18.2 (0.72)	8.4 (0.33)	12.3 (0.48)	8.7 (0.34)
ACC-3.5	16.1 (0.63)	16.1 (0.63)	10.8 (0.43)	6.2 (0.24)	4.0 (0.16)
ACC-6.5	25.1 (0.99)	25.1 (0.99)	12.6 (0.50)	10.4 (0.41)	7.0 (0.28)
ACC-12	33.5 (1.32)	27.7 (1.09)	23.7 (0.93)	16.2 (0.64)	13.0 (0.51)

SADDLE TIE MOUNTS

- Fixing base and curved design gives additional support to the cables
- Applied with screw or bolt for excellent security, particularly in areas of high vibration
- Design for holding heavier cable bundles
- Material: Polyamide 6,6, UL94V-2
- Color: Natural, black and all colors are available

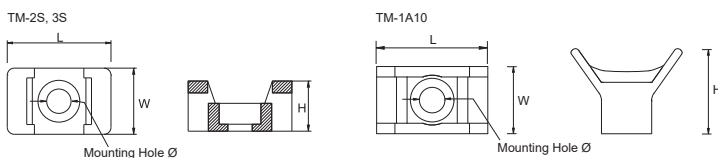
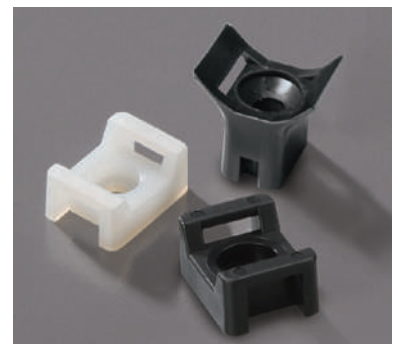

Part No.	Length (L) mm (inch)	Width (W) mm (inch)	Height (H) mm (inch)	Mounting Hole ø mm (inch)	Max. Tie Width mm (inch)
TM-2S6	14.9 (0.59)	9.5 (0.37)	7.2 (0.28)	3.7 (0.15)	4.8 (0.19)
TM-2S8	14.9 (0.59)	9.5 (0.37)	7.2 (0.28)	4.5 (0.18)	4.8 (0.19)
TM-3S8	21.9 (0.86)	15.9 (0.63)	9.7 (0.38)	4.5 (0.18)	9.0 (0.35)
TM-3S10	21.9 (0.86)	15.9 (0.63)	9.7 (0.38)	5.0 (0.20)	9.0 (0.35)
TM-3S25	21.9 (0.86)	15.9 (0.63)	9.7 (0.38)	6.4 (0.25)	9.0 (0.35)
TM-1A10	22.7 (0.89)	13.6 (0.54)	17.2 (0.68)	5.0 (0.20)	9.0 (0.35)

KNOCK-IN LOW PROFILE MOUNTS

- The special 'diagonal' design of the fixing guarantees a secure installation at all times
- Once installed the mounts offer a firm fixing a wide variety of cable ties
- The two-piece 'wedge' ensures that once installed the mounts will not come away from the panel, ideal for use where a high pull out force is required
- Particularly designed for the areas with restricted access
- Material: Polyamide 6,6, UL94V-2
- Color: Natural

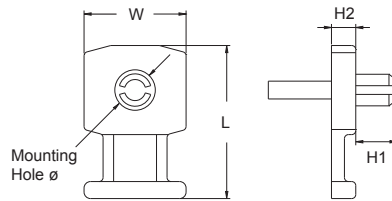
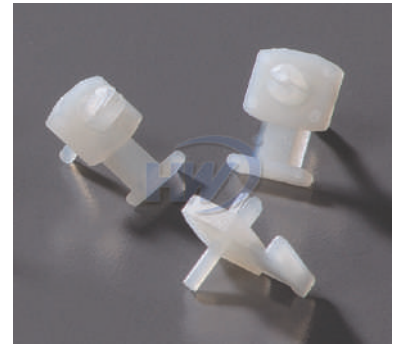

Part No.	L mm (inch)	W mm (inch)	H1 mm (inch)	H2 mm (inch)	Mounting Hole ø mm (inch)	Max. Tie Width mm (inch)
KM-K36	18.9 (0.74)	12.6 (0.50)	5.1 (0.20)	3.0 (0.12)	3.6 (0.14)	4.8 (0.19)
KM-K43	18.9 (0.74)	12.6 (0.50)	5.1 (0.20)	3.0 (0.12)	4.3 (0.17)	4.8 (0.19)
KM-K50	18.9 (0.74)	12.6 (0.50)	5.1 (0.20)	3.0 (0.12)	5.0 (0.20)	4.8 (0.19)

SCREW APPLIED LOW PROFILE MOUNTS

- Installed "outside serrated" and take up no more space than the cable itself
- Particularly used in telecoms equipment, switch gear and control cabinets
- Particularly suitable for applications with minimal space
- Material: Polyamide 6,6, UL94V-2
- Color: Natural

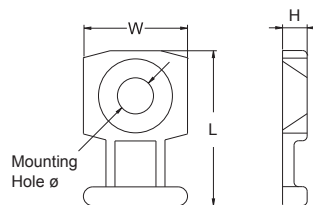

Part No.	L mm (inch)	W mm (inch)	H mm (inch)	Mounting Hole ø mm (inch)	Max. Tie Width mm (inch)
SM-5	10.2 (0.40)	8.1 (0.32)	2.5 (0.10)	3.5 (0.14)	2.5 (0.10)
SM-8	18.9 (0.74)	12.6 (0.50)	3.0 (0.12)	4.4 (0.17)	4.8 (0.19)

CABLE CLAMPS

- Light weight design with strong fixing particularly suitable for use in areas of aircraft and aerospace
- Material: Polyamide 6,6, UL94V-2
- Color: Natural, black

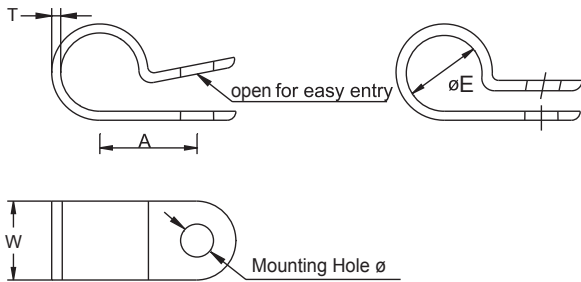
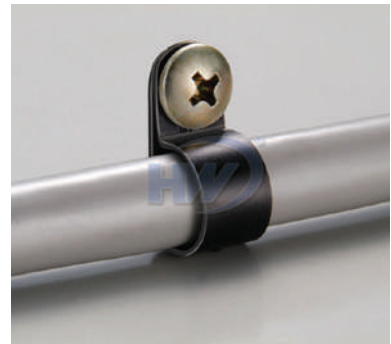

Part No.	Mounting Hole Centers (A) mm (inch)	Width (W) mm (inch)	Thickness (T) mm (inch)	Max.Bundle ø (E) mm (inch)	Mounting Hole ø mm (inch)
GCL-1/8S	8.2 (0.32)	9.1 (0.36)	1.3 (0.05)	3.3 (0.13)	5.5 (0.21)
GCL-3/16S	9.6 (0.38)	9.1 (0.36)	1.3 (0.05)	4.8 (0.19)	5.5 (0.21)
GCL-1/4S	10.3 (0.41)	9.1 (0.36)	1.3 (0.05)	6.6 (0.26)	5.5 (0.21)
GCL-5/16S	10.6 (0.42)	9.1 (0.36)	1.3 (0.05)	7.8 (0.31)	5.5 (0.21)
GCL-1/2S	23.8 (0.94)	9.4 (0.37)	1.3 (0.05)	12.7 (0.5)	5.4 (0.21)
GCL-5/16L	10.6 (0.42)	12.7 (0.50)	1.3 (0.05)	7.6 (0.30)	4.4 (0.17)
GCL-3/8S	11.9 (0.47)	9.2 (0.36)	1.3 (0.05)	9.7 (0.38)	5.5 (0.21)
GCL-1/8	9.1 (0.36)	12.7 (0.50)	1.5 (0.06)	2.9 (0.11)	5.4 (0.21)
GCL-1/4	11.4 (0.45)	12.7 (0.50)	1.5 (0.06)	5.9 (0.23)	5.3 (0.21)
GCL-3/8	13.4 (0.53)	12.1 (0.48)	1.5 (0.06)	9.1 (0.36)	5.3 (0.21)
GCL-1/2	15.0 (0.59)	12.7 (0.50)	1.5 (0.06)	12.2 (0.48)	5.3 (0.21)
GCL-9/16	15.8 (0.62)	12.7 (0.50)	1.5 (0.06)	13.8 (0.54)	5.3 (0.21)
GCL-5/8	27.2 (1.07)	12.4 (0.49)	1.3 (0.05)	15.5 (0.61)	5.3 (0.21)
GCL-3/4	19.8 (0.78)	12.7 (0.50)	1.5 (0.06)	18.6 (0.73)	5.3 (0.21)
GCL-7/8	21.4 (0.84)	12.7 (0.50)	1.5 (0.06)	21.8 (0.86)	5.3 (0.21)
GCL-1-1/8	24.6 (0.97)	12.7 (0.50)	1.5 (0.06)	27.9 (1.10)	5.3 (0.21)

MOUNTING BASES

- Suitable for use in a wide range of materials including concrete, brick, block or wood
- The extended head allows the bundles to be located at a distance from the brickwork with the holders
- The holders, in conjunction with a cable tie, can be used either indoors or outdoors for a diverse range of applications from holding climbing plants, to securing cables running between buildings
- Material: Polyamide 6,6, UL94V-2
- Color: Black

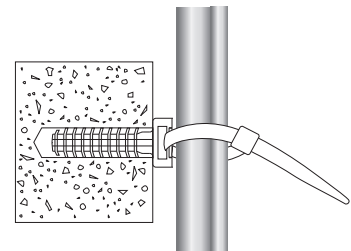
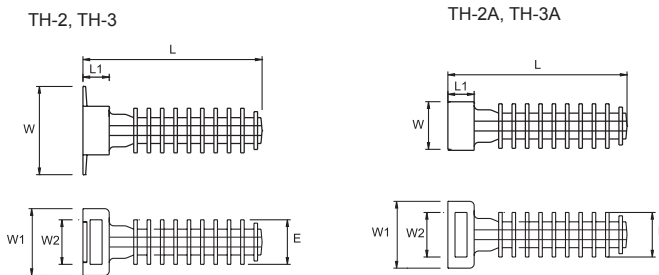

Part No.	L mm (inch)	L1 mm (inch)	W mm (inch)	W1 mm (inch)	W2 mm (inch)	E mm (inch)	Drill Hole ϕ mm (inch)	Max. Tie Width mm (inch)
TH-2	40.5 (1.59)	5.9 (0.23)	20.0 (0.79)	15.0 (0.59)	10.0 (0.39)	9.5 (0.37)	8.0 (0.31)	9.0 (0.35)
TH-2A	40.5 (1.59)	5.9 (0.23)	10.9 (0.43)	15.0 (0.59)	10.0 (0.39)	9.5 (0.37)	8.0 (0.31)	9.0 (0.35)
TH-3	37.5 (1.48)	5.9 (0.23)	20.0 (0.79)	15.0 (0.59)	10.0 (0.39)	8.0 (0.31)	7.0 (0.28)	9.0 (0.35)
TH-3A	37.5 (1.48)	5.9 (0.23)	10.9 (0.43)	15.0 (0.59)	10.0 (0.39)	8.0 (0.31)	7.0 (0.28)	9.0 (0.35)

SELF ADHESIVE TWIST LOCKS

- Strong adhesion for quick and easy installation
- Reusable and releasable for easy wire bundling
- Easy open-and-twist fit to cables
- Material: Polyamide 6,6, UL94V-2
- Color: Natural

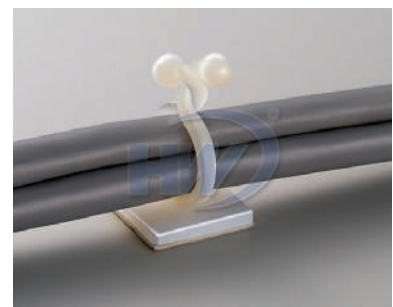
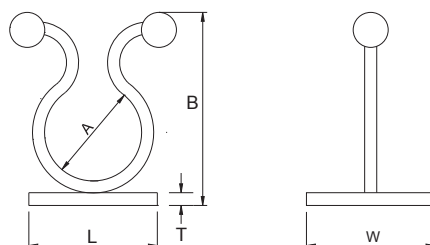

Part No.	L mm (inch)	W mm (inch)	T mm (inch)	A mm (inch)	B mm (inch)	Max. Bundle ϕ mm (inch)
HW-8Aa	17.0 (0.70)	20.0 (0.79)	2.0 (0.08)	8.6 (0.34)	24.1 (0.95)	7.6 (0.30)
HW-8Ab	20.0 (0.79)	20.0 (0.79)	2.0 (0.08)	16.0 (0.70)	32.0 (1.26)	15.0 (0.59)

TWIST LOCKS

- Reusable and releasable for easy wire bundling
- Easy open-and-twist to cables
- Material: Polyamide 6,6, UL94V-2
- Color: Natural

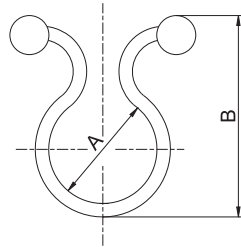

Part No.	A mm (inch)	B mm (inch)	Max.Bundle ϕ mm (inch)
TH-E	5.2 (0.21)	21.0 (0.83)	4.5 (0.18)
TH-F	8.3 (0.33)	25.2 (0.99)	7.3 (0.29)
TH-G	11.5 (0.45)	30.9 (1.22)	10.5 (0.41)
TH-H	15.0 (0.59)	35.1 (1.38)	14.0 (0.55)

Part No.	A mm (inch)	B mm (inch)	Max.Bundle ϕ mm (inch)
TH-I	18.0 (0.71)	40.0 (1.58)	17.0 (0.70)
TH-J	19.5 (0.77)	42.5 (1.67)	19.0 (0.75)
TH-K	22.5 (0.89)	45.5 (1.79)	22.0 (0.87)

TWIST LOCK WITH STANDOFF

- To separate wires from the board for avoiding hot components' interference
- Cable and wire bundles load and unload with a fingertip twist
- Material: Polyamide 6,6, UL94V-2
- Color: Natural

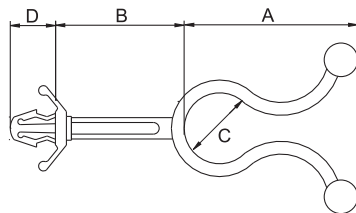

Part No.	A mm (inch)	B mm (inch)	C mm (inch)	D mm (inch)	Max.Bundle ϕ mm (inch)	Mounting Hole ϕ mm (inch)	Panel Thickness mm (inch)
TH-A	28.4 (1.12)	21.0 (0.83)	12.0 (0.47)	7.5 (0.30)	11.0 (0.43)	4.8 (0.19)	2.2 (0.09)
TH-B	19.4 (0.76)	33.5 (1.32)	6.0 (0.24)	7.5 (0.30)	5.0 (0.20)	4.8 (0.19)	2.2 (0.09)
TH-B1	19.0 (0.75)	6.0 (0.24)	6.0 (0.24)	7.5 (0.30)	5.0 (0.20)	4.8 (0.19)	2.2 (0.09)
TH-B2	19.4 (0.76)	33.5 (1.32)	5.5 (0.22)	7.5 (0.30)	4.5 (0.18)	4.8 (0.19)	2.2 (0.09)
TH-C	26.3 (1.04)	4.7 (0.19)	11.0 (0.43)	7.5 (0.30)	10.0 (0.39)	4.8 (0.19)	2.2 (0.09)

WIRE PUSH IN CLIPS

- The shape of the wire saddle ensures that they can accept either single or multiple cables, whilst the design of the cable entry allows cables to be simply pushed into place
- The self-locking feature ensures that once inside the saddle the wires cannot be removed accidentally
- The arrowhead design of fixing ensures simple and secure installation and only needs access to the panel from one side
- With the increased complexity of electronic and electrical installations the use of the wire saddle enables cables to be installed using the minimum amount of space, a typical application would be in the frames/ rail of control cabinets
- Material: Polyamide 6,6, UL94V-2
- Color: Natural

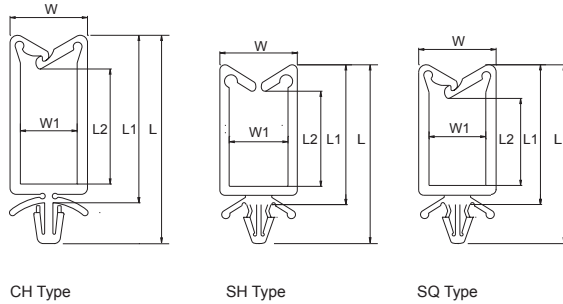
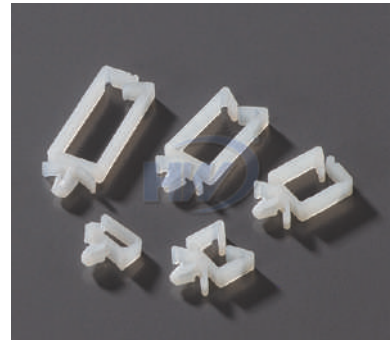

Part No.	L mm (inch)	L1 mm (inch)	L2 mm (inch)	W mm (inch)	W1 mm (inch)	Mounting Hole ϕ mm (inch)	Panel Thickness mm (inch)
CH-A	25.9 (1.02)	18.0 (0.71)	8.8 (0.35)	15.0 (0.59)	11.0 (0.43)	4.8 (0.19)	1.7 (0.07)
CH-B	34.9 (1.37)	27.0 (1.06)	17.5 (0.69)	15.0 (0.59)	11.0 (0.43)	4.8 (0.19)	1.7 (0.07)
CH-C	42.9 (1.69)	35.0 (1.38)	26.0 (1.02)	15.0 (0.59)	11.0 (0.43)	4.8 (0.19)	1.7 (0.07)
SH-A	21.8 (0.86)	13.2 (0.52)	4.8 (0.19)	15.0 (0.59)	11.4 (0.45)	4.8 (0.19)	2.2 (0.09)
SH-B	27.0 (1.06)	18.4 (0.72)	9.8 (0.39)	15.0 (0.59)	11.4 (0.45)	4.8 (0.19)	2.2 (0.09)
SH-C	35.8 (1.41)	27.2 (1.07)	19.0 (0.75)	15.0 (0.59)	11.4 (0.45)	4.8 (0.19)	2.2 (0.09)
SH-D	43.8 (1.72)	35.2 (1.39)	26.9 (1.06)	15.0 (0.59)	11.4 (0.45)	4.8 (0.19)	2.2 (0.09)
SQ-A	20.7 (0.81)	13.1 (0.52)	4.8 (0.19)	15.0 (0.59)	11.2 (0.44)	4.8 (0.19)	2.0 (0.08)
SQ-B	25.7 (1.01)	18.1 (0.71)	10.0 (0.39)	15.0 (0.59)	11.2 (0.44)	4.8 (0.19)	2.0 (0.08)
SQ-C	34.7 (1.37)	27.1 (1.07)	19.0 (0.75)	15.0 (0.59)	11.2 (0.44)	4.8 (0.19)	2.0 (0.08)
SQ-D	42.9 (1.69)	35.3 (1.39)	27.0 (1.06)	15.0 (0.59)	11.2 (0.44)	4.8 (0.19)	2.0 (0.08)

WIRE SADDLES

- The shape of the wire saddle ensures that they can accept either single or multiple cables, whilst the design of the cable entry allows cables to be simply pushed into place
- The self-locking feature ensures that once inside the saddle the wires cannot be removed accidentally
- The arrowhead design of fixing ensures simple and secure installation and only needs access to the panel from one side
- With the increased complexity of electronic and electrical installations, the use of the wire saddle enables cables to be installed using the minimum amount of space, a typical application would be in the frames/ rail of control cabinets
- Material: Polyamide 6,6, UL94V-2
- Color: Natural

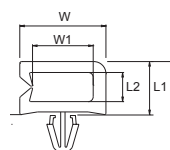

Part No.	L mm (inch)	L1 mm (inch)	L2 mm (inch)	W mm (inch)	W1 mm (inch)	Mounting Hole ϕ mm (inch)	Panel Thickness mm (inch)
WH-A	15.0 (0.59)	8.2 (0.32)	4.8 (0.19)	14.2 (0.60)	10.0 (0.39)	4.8 (0.19)	1.6 (0.06)

CABLE CLIPS

- Fixable, good elasticity, to bear collision, unable broken
- Inserted nail, nail stick to plastic seat, save time and cost down
- Material: Polyethylene (plastic body), carbon steel (nail)
- Color: Mostly grey and white, other colors are also available

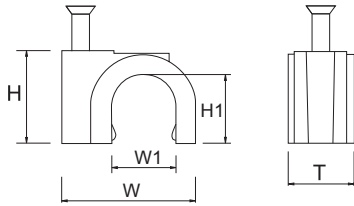

Part No.	W mm (inch)	W1 mm (inch)	H mm (inch)	H1 mm (inch)	T mm (inch)	Nails mm (inch)
GC-0.35	8.6 (0.34)	3.5 (0.14)	5.9 (0.23)	3.7 (0.15)	5.0 (0.20)	ø2.0x15 (0.08x0.60)
GC-0.4	10.0 (0.39)	4.0 (0.16)	6.6 (0.26)	4.2 (0.17)	5.2 (0.20)	ø2.5x18 (0.10x0.71)
GC-0.5	12.0 (0.47)	5.0 (0.20)	7.6 (0.30)	5.3 (0.21)	6.3 (0.25)	ø2.5x18 (0.10x0.71)
GC-1	12.4 (0.49)	6.0 (0.24)	9.0 (0.35)	6.6 (0.26)	6.3 (0.25)	ø2.5x20 (0.10x0.79)
GC-1.5	14.3 (0.56)	7.0 (0.28)	11.0 (0.43)	7.2 (0.28)	6.3 (0.25)	ø2.5x22 (0.10x0.87)
GC-2	14.8 (0.58)	8.0 (0.31)	11.5 (0.45)	8.6 (0.34)	6.8 (0.27)	ø2.5x22 (0.10x0.87)
GC-2.5	17.6 (0.69)	9.0 (0.35)	12.0 (0.47)	9.0 (0.35)	7.0 (0.28)	ø2.5x25 (0.10x0.99)
GC-3	17.9 (0.70)	10.0 (0.39)	13.4 (0.53)	10.5 (0.41)	7.0 (0.28)	ø2.5x27 (0.10x1.07)
GC-3.5	18.7 (0.74)	11.0 (0.43)	16.6 (0.65)	12.2 (0.48)	9.0 (0.35)	ø2.5x27 (0.10x1.07)
GC-4	20.0 (0.79)	12.0 (0.47)	16.0 (0.63)	12.5 (0.49)	9.0 (0.35)	ø2.5x27 (0.10x1.07)
GC-6	22.0 (0.87)	14.0 (0.55)	20.5 (0.81)	15.6 (0.61)	9.0 (0.35)	ø3.0x35 (0.12x1.38)
GC-7	25.0 (0.98)	16.0 (0.63)	21.7 (0.85)	17.0 (0.67)	11.8 (0.46)	ø3.2x38 (0.13x1.50)
GC-7S	25.0 (0.98)	16.0 (0.63)	21.7 (0.85)	17.0 (0.67)	11.8 (0.46)	ø2.5x38 (0.10x1.50)
GC-7.2	27.8 (1.09)	18.0 (0.71)	22.0 (0.87)	17.5 (0.69)	10.6 (0.42)	ø3.2x38 (0.13x1.50)
GC-7.5	29.0 (1.14)	20.0 (0.79)	23.5 (0.93)	18.5 (0.73)	10.4 (0.41)	ø3.2x38 (0.13x1.50)
GC-7.5S	29.0 (1.14)	20.0 (0.79)	23.5 (0.93)	18.5 (0.73)	10.4 (0.41)	ø2.5x38 (0.10x1.50)
GC-8	32.7 (1.29)	22.0 (0.87)	27.8 (1.09)	22.5 (0.89)	11.0 (0.43)	ø3.2x42 (0.13x1.66)
GC-9	39.0 (1.54)	25.0 (0.98)	31.6 (1.24)	26.0 (1.02)	13.0 (0.51)	ø3.2x47 (0.13x1.86)
GC-10	45.5 (1.79)	32.0 (1.26)	40.0 (1.57)	33.5 (1.32)	13.7 (0.54)	ø3.6x56 (0.15x2.21)
GCR-3.5	8.5 (0.33)	3.5 (0.14)	5.0 (0.20)	3.2 (0.13)	5.1 (0.20)	ø1.5x18 (0.06x0.71)
GCR-6	12.0 (0.47)	5.5 (0.22)	7.5 (0.30)	5.5 (0.22)	6.0 (0.24)	ø2.0x24 (0.08x0.95)
GCR-7	13.3 (0.52)	7.0 (0.28)	8.5 (0.33)	6.5 (0.26)	6.8 (0.27)	ø2.0x24 (0.08x0.95)
GCR-8	15.0 (0.59)	7.0 (0.28)	10.0 (0.39)	7.5 (0.30)	8.0 (0.31)	ø2.0x24 (0.08x0.95)

CONTRACT FINISH CABLE CLIPS

- Fixable, good elasticity, to bear collision, unable broken
- Inserted nail, nail stick to plastic seat, save time and cost down
- Material: Polyethylene (plastic body), carbon steel (nail)
- Color: Mostly white, other colors are also available

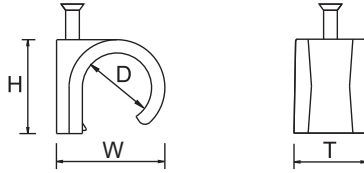

Part No.	W mm (inch)	T mm (inch)	H mm (inch)	D mm (inch)	Nails mm (inch)
GB-1	8.4 (0.33)	7.0 (0.28)	4.8 (0.19)	3.0 (0.12)	ø1.5x21 (0.06x0.83)
GB-2	10.0 (0.39)	6.0 (0.24)	7.0 (0.28)	4.6 (0.18)	ø1.8x26 (0.08x1.03)
GB-3	12.0 (0.47)	8.8 (0.35)	9.2 (0.36)	7.0 (0.28)	ø1.8x26 (0.08x1.03)
GB-4	14.8 (0.58)	9.6 (0.38)	12.5 (0.49)	9.5 (0.37)	ø1.8x26 (0.08x1.03)
GB-5	20.0 (0.79)	11.8 (0.46)	17.0 (0.67)	14.8 (0.58)	ø2.5x40 (0.10x1.58)

FLAT CABLE CLIPS

- Fixable, good elasticity, to bear impact, unable broken
- Inserted nail, nail stick to plastic seat, save time and cost down
- Material: Polyethylene (plastic body), carbon steel (nail)
- Color: Mostly white, other colors are also available

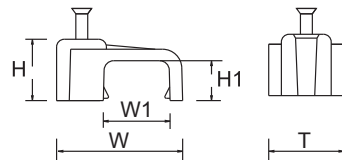

Part No.	W mm (inch)	W1 mm (inch)	H mm (inch)	H1 mm (inch)	T mm (inch)	Nails mm (inch)
GF-0.7	12.0 (0.47)	5.5 (0.22)	5.4 (0.21)	3.1 (0.12)	7.0 (0.28)	ø2.0x15 (0.08x0.60)
GF-1.2	13.0 (0.51)	6.2 (0.24)	5.4 (0.21)	3.8 (0.15)	7.4 (0.29)	ø2.0x15 (0.08x0.60)
GF-1.6	14.5 (0.57)	8.0 (0.31)	8.0 (0.31)	5.0 (0.20)	9.3 (0.37)	ø2.0x15 (0.08x0.60)
GF-2.0	16.0 (0.63)	8.5 (0.33)	8.0 (0.31)	5.0 (0.20)	9.9 (0.39)	ø2.5x18 (0.10x0.71)
GF-2.2	17.2 (0.68)	10.0 (0.39)	10.0 (0.39)	6.5 (0.26)	9.9 (0.39)	ø2.5x22 (0.10x0.87)
GFC-PT	10.1 (0.40)	5.0 (0.20)	3.6 (0.14)	1.8 (0.07)	5.4 (0.21)	ø1.5x15 (0.06x0.60)
GFC-0.75	10.8 (0.43)	6.0 (0.24)	6.2 (0.24)	4.1 (0.16)	6.2 (0.24)	ø1.5x18 (0.06x0.71)
GFC-1.0	15.8 (0.62)	8.0 (0.31)	7.5 (0.30)	4.3 (0.17)	9.4 (0.37)	ø2.0x24 (0.08x0.95)
GFC-1.5	16.5 (0.65)	9.0 (0.35)	7.8 (0.31)	5.0 (0.20)	9.5 (0.37)	ø2.0x24 (0.08x0.95)
GFC-2.0	19.3 (0.76)	11.3 (0.44)	8.0 (0.31)	5.0 (0.20)	10.6 (0.42)	ø2.0x24 (0.08x0.95)
GFC-2.5	17.0 (0.67)	10.0 (0.39)	8.3 (0.33)	5.3 (0.21)	10.5 (0.41)	ø2.0x24 (0.08x0.95)
GFC-4.0	19.6 (0.77)	11.4 (0.45)	9.6 (0.38)	6.5 (0.26)	10.5 (0.41)	ø2.0x24 (0.08x0.95)
GFC-6.0	21.0 (0.83)	13.5 (0.53)	10.5 (0.41)	7.2 (0.28)	10.5 (0.41)	ø2.0x29 (0.08x1.15)
GFC-10	24.3 (0.96)	17.2 (0.68)	11.6 (0.46)	8.6 (0.34)	10.3 (0.41)	ø2.0x29 (0.08x1.15)
GFC-16	28.0 (1.10)	20.1 (0.79)	13.4 (0.53)	10.2 (0.40)	12.0 (0.47)	ø2.5x34 (0.10x1.34)

DUAL NAILS FLAT CABLE CLIPS

- Fixable, good elasticity, to bear collision, unable broken
- Inserted nail, nail stick to plastic seat, save time and cost down
- Dual nail could strengthen adhesion
- Suitable for fastening big flat wires
- Material: Polyethylene (plastic body), carbon steel (nail)
- Color: Mostly white, other colors are also available

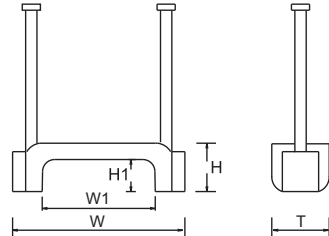
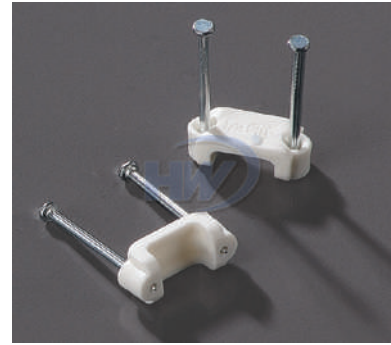

Part No.	W mm (inch)	W1 mm (inch)	H mm (inch)	H1 mm (inch)	T mm (inch)	Nails mm (inch)
GNF-13H	23.4 (0.92)	13.8 (0.54)	9.4 (0.37)	6.8 (0.27)	9.4 (0.37)	ø1.8x31 (0.07x1.23)
GNF-19H	29.8 (1.17)	19.5 (0.77)	9.4 (0.37)	6.8 (0.27)	9.5 (0.37)	ø1.8x31 (0.07x1.23)

DUAL NAILS CABLE CLIPS

- Fixable, good elasticity, to bear impact, unable broken
- Inserted nail, nail stick to plastic seat, save time and cost down
- Dual nail could strengthen adhesion
- Suitable for fasten large PVC pipe or cables
- Material: Polyethylene (plastic body), carbon steel (nail)
- Color: Mostly grey, other colors are also available

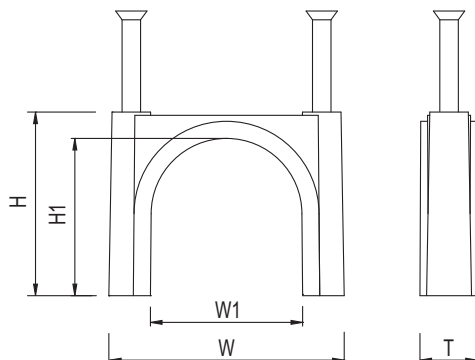

Part No.	W mm (inch)	W1 mm (inch)	H mm (inch)	H1 mm (inch)	T mm (inch)	Nails mm (inch)
GNC-11	60.3 (2.37)	40.0 (1.57)	50.4 (1.98)	41.7 (1.64)	13.0 (0.51)	ø4.0x68 (0.16x2.68)
GNC-12	74.7 (2.94)	49.0 (1.93)	57.7 (2.27)	51.5 (2.03)	15.5 (0.61)	ø4.0x78 (0.16x3.08)
GNC-14	83.7 (3.30)	62.0 (2.44)	71.8 (2.83)	62.4 (2.46)	17.2 (0.68)	ø4.5x97 (0.18x3.82)

WALL PLUGS

- 4-way expansion form lock guarantees highest grip
- Anti-rotation lugs prevent the plug rotating in the drill hole
- The special spread-free neck prevents damage of tiles and plaster
- Simple and quick push-through installation reduces installation time
- Material: Polyamide 6, UL94V-2
- Color: Grey, RAL 7035



Anchor

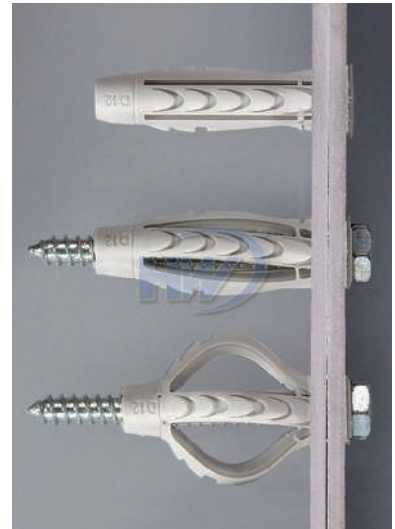
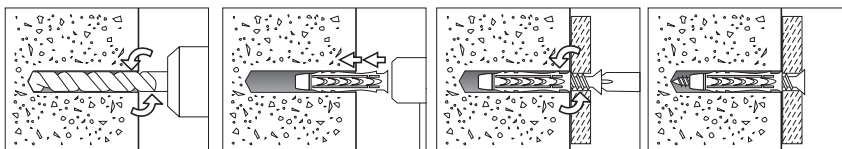
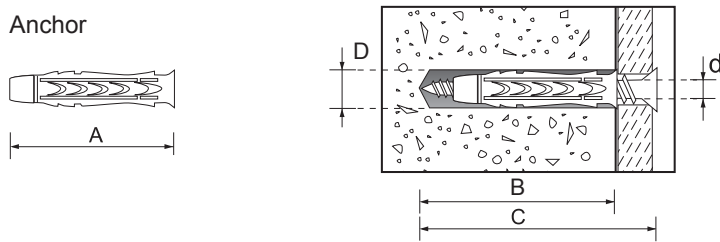

Fastening System
Fasteners



Part No.	Anchor Length (A) mm (inch)	Drill Hole Ø (D) mm (inch)	Drill Hole Depth (B) mm (inch)	Screw Size (dxC) mm (inch)
WA-D5	25.4 (1.00)	5.8 (0.23)	35.0 (1.38)	ø4.0 x 30~35 (ø0.16x1.18~1.38)
WA-D6	30.0 (1.18)	6.0 (0.24)	40.0 (1.57)	ø4.5 x 35~40 (ø0.18x1.38~1.57)
WA-D8	40.0 (1.57)	8.0 (0.31)	50.0 (1.97)	ø5.0 x 45~50 (ø0.20x1.77~1.97)
WA-D10	50.0 (1.97)	10.0 (0.39)	70.0 (2.76)	ø6.5 x 55~70 (ø0.26x2.17~2.76)
WA-D12	60.0 (2.36)	12.0 (0.47)	80.0 (3.15)	ø7.5 x 65~80 (ø0.30x2.56~3.15)

* Screws are available upon request



Paper Box

DUAL LOCKING PCB SUPPORTS

- CBS-A type:
 - Installed easily and quickly by hand
 - Barbed arrow mounts on both ends locking securely
 - This support can be shaped to lock in the board for PCB/PCB or PCB/ CHASSIS spacer
- CBS-K type:
 - None tool are required in installation
 - Reusable
 - Pinch head are easily plugged in and pulled out
- Material: Polyamide 6,6, UL94V-2
- Color: Natural

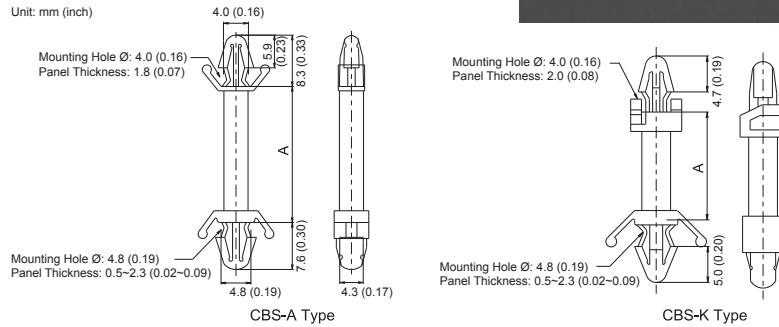

Part No.	Spacing Height (A) mm (inch)
CBS-5A	4.6±0.3 (0.18±0.01)
CBS-6A	6.2±0.3 (0.24±0.01)
CBS-9A	9.2±0.3 (0.36±0.01)
CBS-13A	12.6±0.3 (0.50±0.01)
CBS-16A	15.8±0.3 (0.62±0.01)
CBS-19A	19.1±0.3 (0.75±0.01)
CBS-22A	22.2±0.3 (0.87±0.01)
CBS-25A	25.3±0.3 (1.00±0.01)
CBS-29A	28.6±0.3 (1.13±0.01)
CBS-35A	33.3±0.3 (1.31±0.01)

Part No.	Spacing Height (A) mm (inch)
CBS-6K	6.3±0.3 (0.25±0.01)
CBS-8K	7.8±0.3 (0.31±0.01)
CBS-9K	9.3±0.3 (0.37±0.01)
CBS-12K	11.7±0.3 (0.46±0.01)
CBS-13K	12.6±0.3 (0.50±0.01)
CBS-16K	15.7±0.3 (0.62±0.01)
CBS-19K	19.1±0.3 (0.75±0.01)
CBS-22K	22.1±0.3 (0.87±0.01)
CBS-25K	25.1±0.3 (0.99±0.01)
CBS-29K	28.5±0.3 (1.12±0.01)
CBS-35K	35.0±0.3 (1.38±0.01)

DUAL LOCKING PCB SUPPORTS

- Mini size saves space
- Installed by hand with no screws
- After board have support installed, the PCB support hold them firmly in place
- Snap together to stack more boards in limited space
- Material: Polyamide 6,6, UL94V-2
- Color: Natural



Part No.	Spacing Height (A) mm (inch)	Spacing Height (B) mm (inch)
MCBS-7W	7.2±0.3 (0.28±0.01)	12.7±0.3 (0.50±0.01)
MCBS-9W	9.3±0.3 (0.37±0.01)	14.5±0.3 (0.57±0.01)
MCBS-11W	11.3±0.3 (0.45±0.01)	18.2±0.3 (0.72±0.01)
MCBS-13W	13.3±0.3 (0.52±0.01)	20.2±0.3 (0.80±0.01)
MCBS-13WN	13.3±0.3 (0.52±0.01)	20.2±0.3 (0.80±0.01)

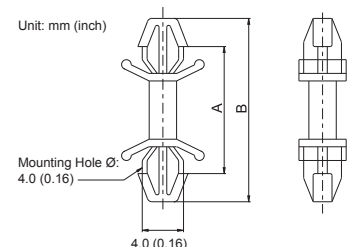

REST MOUNT PCB SUPPORTS

- Support and stabilize printed circuit boards
- Material: Polyamide 6,6, UL94V-2
- Color: Natural

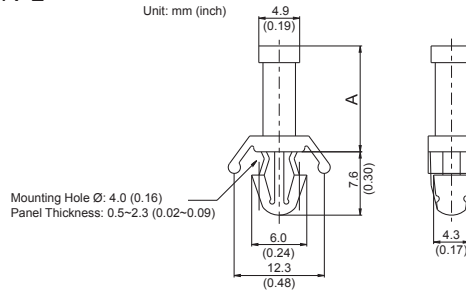

Part No.	Spacing Height (A) mm (inch)
CBS-5P	4.7±0.3 (0.19±0.01)
CBS-6P	6.3±0.3 (0.25±0.01)
CBS-9P	9.3±0.3 (0.37±0.01)
CBS-13P	12.6±0.3 (0.50±0.01)
CBS-16P	15.9±0.3 (0.63±0.01)

Part No.	Spacing Height (A) mm (inch)
CBS-19P	19.0±0.3 (0.75±0.01)
CBS-22P	22.2±0.3 (0.87±0.01)
CBS-25P	25.2±0.3 (0.99±0.01)
CBS-29P	28.6±0.3 (1.13±0.01)
CBS-35P	33.4±0.3 (1.32±0.01)

Fastening System
Fasteners

PCB SUPPORTS

- Fix and separate printed circuit boards, easy to remove without tools
- Material: Polyamide 6,6, UL94V-2
- Color: Natural

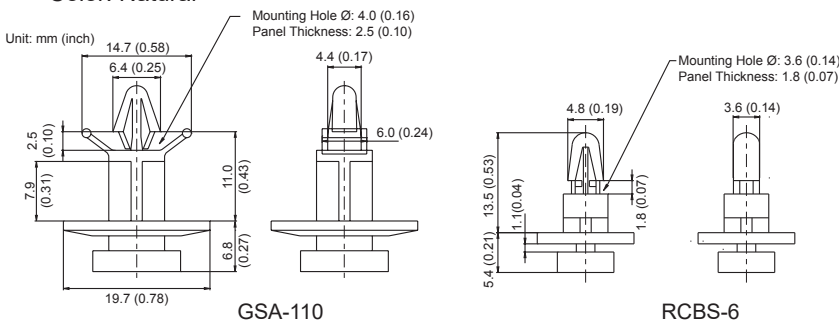

REVERSE LOCKING PCB SUPPORTS

- Hole or slots needed on board can support for heavily loaded printed circuit boards
- Minimum protrusion under chassis
- Material: Polyamide 6,6, UL94V-2
- Color: Natural



Part No.	A mm (inch)	\varnothing B mm (inch)	C mm (inch)
CBS-6RS	5.8 (0.23)	\varnothing 10.0 (0.39)	1.0 (0.04)
CBS-7RS	6.8 (0.27)	\varnothing 10.0 (0.39)	1.0 (0.04)
CBS-8RS	8.0 (0.32)	\varnothing 10.0 (0.39)	1.0 (0.04)
CBS-10RS	10.0 (0.39)	\varnothing 10.0 (0.39)	1.0 (0.04)
CBS-12RS	12.0 (0.47)	\varnothing 10.0 (0.39)	1.0 (0.04)
CBS-14RS	14.0 (0.55)	\varnothing 10.0 (0.39)	1.0 (0.04)
CBS-16RS	16.0 (0.63)	\varnothing 10.0 (0.39)	1.0 (0.04)
CBS-18RS	18.0 (0.71)	\varnothing 10.0 (0.39)	1.0 (0.04)

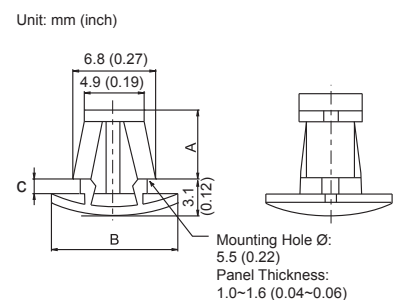

REVERSE LOCKING PCB SUPPORTS

- Thin button head for minimum protrusion
- Sharp head can provide vibration and shake
- Insert the support through both holes from chassis underside
- Material: Polyamide 6,6, UL94V-2
- Color: Natural

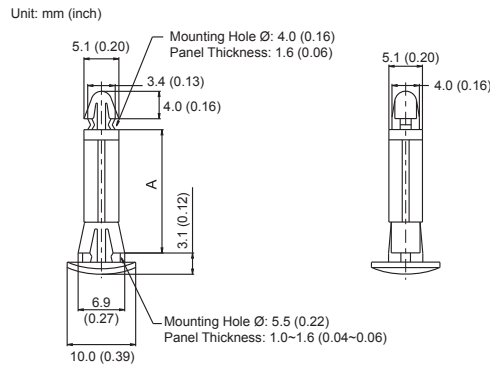

Part No.	Spacing Height (A) mm (inch)
CBS-6R	5.8±0.3 (0.23±0.01)
CBS-7R	6.8±0.3 (0.27±0.01)
CBS-8R	8.0±0.3 (0.32±0.01)
CBS-10R	10.0±0.3 (0.39±0.01)

Part No.	Spacing Height (A) mm (inch)
CBS-12R	12.0±0.3 (0.47±0.01)
CBS-14R	14.0±0.3 (0.55±0.01)
CBS-16R	16.0±0.3 (0.63±0.01)
CBS-18R	18.0±0.3 (0.71±0.01)

SELF ADHESIVE PCB SUPPORTS

- Easy mounting with adhesive tape
- For PCB of 1.6mm (0.063 inch) thick as well as 2mm (0.079 inch) thick
- Mounting hole diameter: $\varnothing 4 \pm 0.1$ mm (0.157 inch)
- Material: Polyamide 6,6, UL94V-2
- Color: Natural

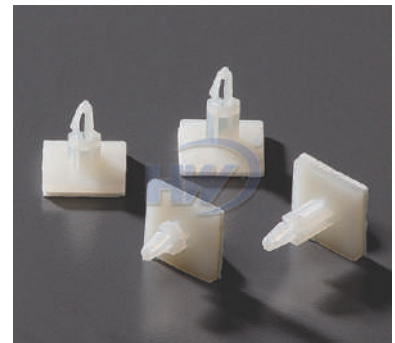
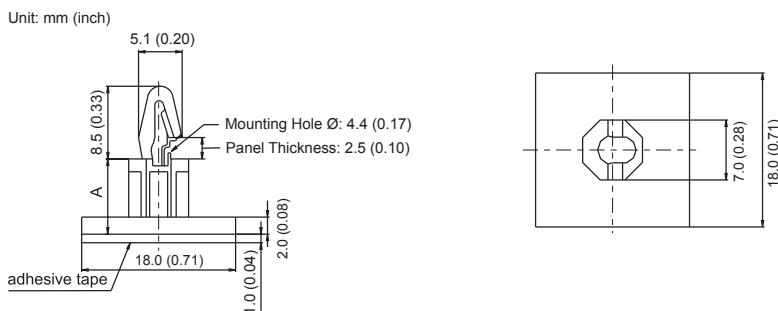

Part No.	Spacing Height (A) mm (inch)
ACBS-6M	5.6±0.3 (0.22±0.01)
ACBS-9M	8.7±0.3 (0.34±0.01)
ACBS-12M	11.9±0.3 (0.47±0.01)

BOLT HEAD PCB SUPPORTS

- Support with minimum chassis protrusion serves for limited space or slim line applications
- Head locks in boards, can be released by hand
- Screw locks support; steady and firm
- Material: Polyamide 6,6, UL94V-2
- Color: Natural

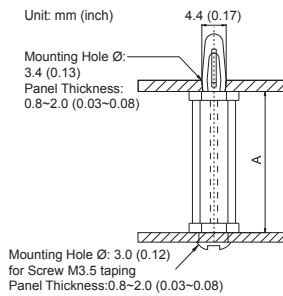

Part No.	Spacing Height (A) mm (inch)
CBS-6S	6.5±0.3 (0.26±0.01)
CBS-9S	9.6±0.3 (0.38±0.01)
CBS-13S	12.9±0.3 (0.51±0.01)
CBS-16S	16.0±0.3 (0.63±0.01)

Part No.	Spacing Height (A) mm (inch)
CBS-19S	19.3±0.3 (0.76±0.01)
CBS-22S	22.4±0.3 (0.88±0.01)
CBS-25S	25.5±0.3 (1.00±0.01)
CBS-29S	29.0±0.3 (1.14±0.01)

MINI CARD SPACER SUPPORTS

- Install by hand no tools required
- Insert the support through only one hole of board
- Thin button head for minimum protrusion can save more space
- Material: Polyamide 6,6, UL94V-2
- Color: Natural



Part No.	Spacing Height (A) mm (inch)
MCBS-4P	4.1±0.3 (0.16±0.01)
MCBS-6P	6.2±0.3 (0.24±0.01)
MCBS-8P	8.2±0.3 (0.32±0.01)
MCBS-10P	11.7±0.3 (0.46±0.01)
MCBS-14P	14.3±0.3 (0.56±0.01)

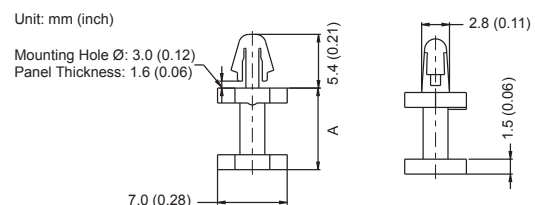

CIRCUIT BOARD BOLTS

- Easily installed by hand to lock securely
- Easily removed by pinching prong tips
- No tools is required
- Material: Polyamide 6,6, UL94V-2
- Color: Natural

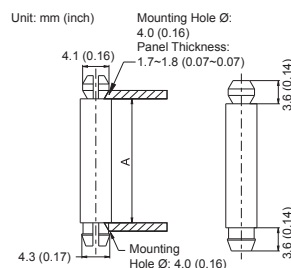

Part No.	Spacing Height (A) mm (inch)
HSP-2N	3.2±0.3 (0.13±0.01)
HSP-5N	4.8±0.3 (0.19±0.01)
HSP-6N	6.3±0.3 (0.25±0.01)
HSP-8N	7.9±0.3 (0.31±0.01)
HSP-9N	9.4±0.3 (0.37±0.01)

Part No.	Spacing Height (A) mm (inch)
HSP-11N	11.3±0.3 (0.45±0.01)
HSP-13N	12.7±0.3 (0.50±0.01)
HSP-16N	15.9±0.3 (0.63±0.01)
HSP-19N	19.1±0.3 (0.75±0.01)
HSP-22N	22.2±0.3 (0.87±0.01)

PLASTIC RIVETS

- For fixture on the circuit board, or electronic apparatus
- Light weight and excellent insulation
- Material: Polyamide 6,6, UL94V-2
- Color: Natural

Part No.: R-1

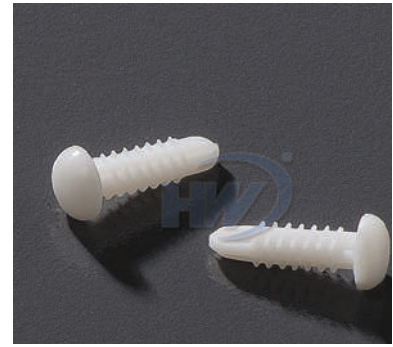
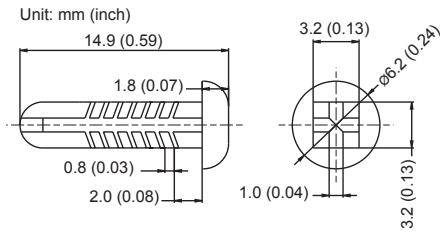

CORD GRIPS

- Application in lighting and electric equipment
- Protect and grip power cable in base hole
- Material: Polyamide 66+GF, UL94V-2
- Color: Black

Part No: 5100/7

Unit: mm (inch)

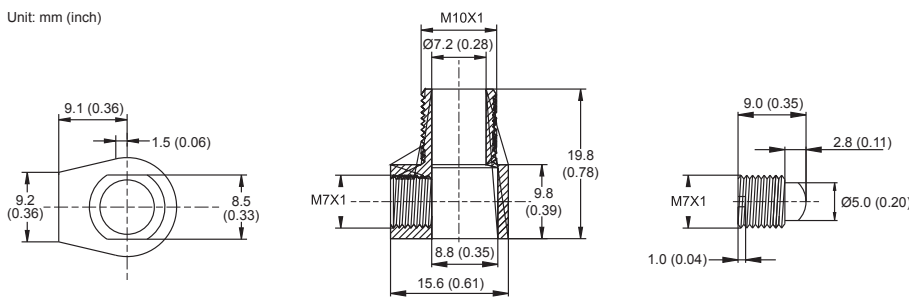

CORD GRIPS

- Application in lighting
- Protect and grip power cable in pipe end
- Material: Polyamide 6,6+GF, UL94V-2
- Color: White, black

Part No: FP-7A

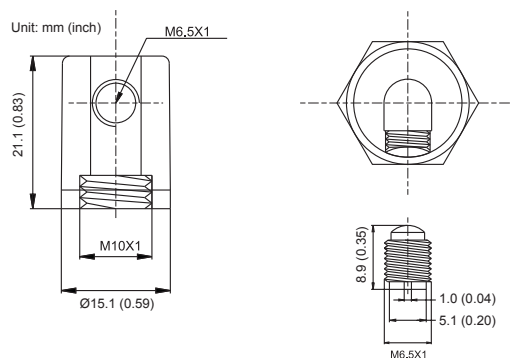

PAN HEAD PHILLIPS SLOTTED SCREWS

- Provide excellent chemical resistance
- Great resistant to wear, high strength with light weight
- Material: Polyamide 6,6, UL94HB
- Color: Natural

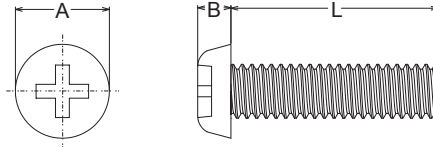

Part No.	Thread	A mm (inch)	B mm (inch)	L mm (inch)
NS-M3-6PP	M3	5.5 (0.22)	2.0 (0.08)	6.0 (0.24)
NS-M3-8PP		5.5 (0.22)	2.0 (0.08)	8.0 (0.31)
NS-M3-10PP		5.5 (0.22)	2.0 (0.08)	10.0 (0.39)
NS-M3-12PP		5.5 (0.22)	2.0 (0.08)	12.0 (0.47)
NS-M3-16PP		5.5 (0.22)	2.0 (0.08)	16.0 (0.63)
NS-M3-20PP		5.5 (0.22)	2.0 (0.08)	20.0 (0.79)
NS-M4-6PP	M4	7.0 (0.28)	3.0 (0.12)	6.0 (0.24)
NS-M4-8PP		7.0 (0.28)	3.0 (0.12)	8.0 (0.31)
NS-M4-10PP		7.0 (0.28)	3.0 (0.12)	10.0 (0.39)
NS-M4-12PP		7.0 (0.28)	3.0 (0.12)	12.0 (0.47)
NS-M4-16PP		7.0 (0.28)	3.0 (0.12)	16.0 (0.63)
NS-M4-20PP		7.0 (0.28)	3.0 (0.12)	20.0 (0.79)
NS-M5-6PP	M5	9.0 (0.35)	3.0 (0.12)	6.0 (0.24)
NS-M5-8PP		9.0 (0.35)	3.0 (0.12)	8.0 (0.31)
NS-M5-10PP		9.0 (0.35)	3.0 (0.12)	10.0 (0.39)
NS-M5-12PP		9.0 (0.35)	3.0 (0.12)	12.0 (0.47)
NS-M5-16PP		9.0 (0.35)	3.0 (0.12)	16.0 (0.63)
NS-M5-20PP		9.0 (0.35)	3.0 (0.12)	20.0 (0.79)
NS-M6-10PP	M6	10.0 (0.39)	3.5 (0.14)	10.0 (0.39)
NS-M6-12PP		10.0 (0.39)	3.5 (0.14)	12.0 (0.47)
NS-M6-16PP		10.0 (0.39)	3.5 (0.14)	16.0 (0.63)
NS-M6-20PP		10.0 (0.39)	3.5 (0.14)	20.0 (0.79)
NS-M8-10PP	M8	14.0 (0.55)	5.4 (0.21)	10.0 (0.39)
NS-M8-12PP		14.0 (0.55)	5.4 (0.21)	12.0 (0.47)
NS-M8-16PP		14.0 (0.55)	5.4 (0.21)	16.0 (0.63)
NS-M8-20PP		14.0 (0.55)	5.4 (0.21)	20.0 (0.79)

FLAT HEAD PHILLIPS SLOTTED SCREWS

- Provide excellent chemical resistance
- Great resistant to wear, high strength with light weight
- Material: Polyamide 6,6, UL94HB
- Color: Natural

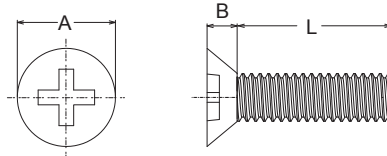

Part No.	Thread	A mm (inch)	B mm (inch)	L mm (inch)
NS-M3-6FP	M3	5.6 (0.22)	2.0 (0.08)	6.0 (0.24)
NS-M3-8FP		5.6 (0.22)	2.0 (0.08)	8.0 (0.31)
NS-M3-10FP		5.6 (0.22)	2.0 (0.08)	10.0 (0.39)
NS-M3-12FP		5.6 (0.22)	2.0 (0.08)	12.0 (0.47)
NS-M3-16FP		5.6 (0.22)	2.0 (0.08)	16.0 (0.63)
NS-M3-20FP		5.6 (0.22)	2.0 (0.08)	20.0 (0.79)
NS-M4-6FP	M4	7.5 (0.30)	2.5 (0.10)	6.0 (0.24)
NS-M4-8FP		7.5 (0.30)	2.5 (0.10)	8.0 (0.31)
NS-M4-10FP		7.5 (0.30)	2.5 (0.10)	10.0 (0.39)
NS-M4-12FP		7.5 (0.30)	2.5 (0.10)	12.0 (0.47)
NS-M4-16FP		7.5 (0.30)	2.5 (0.10)	16.0 (0.63)
NS-M4-20FP		7.5 (0.30)	2.5 (0.10)	20.0 (0.79)
NS-M5-6FP	M5	9.2 (0.36)	2.5 (0.10)	6.0 (0.24)
NS-M5-8FP		9.2 (0.36)	2.5 (0.10)	8.0 (0.31)
NS-M5-10FP		9.2 (0.36)	2.5 (0.10)	10.0 (0.39)
NS-M5-12FP		9.2 (0.36)	2.5 (0.10)	12.0 (0.47)
NS-M5-16FP		9.2 (0.36)	2.5 (0.10)	16.0 (0.63)
NS-M5-20FP		9.2 (0.36)	2.5 (0.10)	20.0 (0.79)
NS-M6-10FP	M6	10.8 (0.43)	3.3 (0.13)	10.0 (0.39)
NS-M6-12FP		10.8 (0.43)	3.3 (0.13)	12.0 (0.47)
NS-M6-16FP		10.8 (0.43)	3.3 (0.13)	16.0 (0.63)
NS-M6-20FP		10.8 (0.43)	3.3 (0.13)	20.0 (0.79)
NS-M8-10FP	M8	16.0 (0.63)	4.7 (0.19)	10.0 (0.39)
NS-M8-12FP		16.0 (0.63)	4.7 (0.19)	12.0 (0.47)
NS-M8-16FP		16.0 (0.63)	4.7 (0.19)	16.0 (0.63)
NS-M8-20FP		16.0 (0.63)	4.7 (0.19)	20.0 (0.79)

HEX HEAD SCREWS

- Provide excellent chemical resistance
- Great resistant to wear, high strength with light weight
- Material: Polyamide 6,6, UL94HB
- Color: Natural

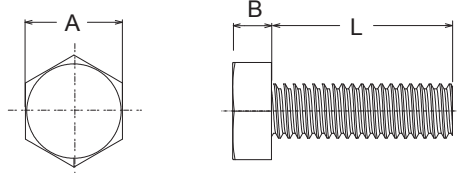

Part No.	Thread	A mm (inch)	B mm (inch)	L mm (inch)
NS-M3-6H	M3	5.5 (0.22)	2.0 (0.08)	6.0 (0.24)
NS-M3-8H		5.5 (0.22)	2.0 (0.08)	8.0 (0.31)
NS-M3-10H		5.5 (0.22)	2.0 (0.08)	10.0 (0.39)
NS-M3-12H		5.5 (0.22)	2.0 (0.08)	12.0 (0.47)
NS-M3-16H		5.5 (0.22)	2.0 (0.08)	16.0 (0.63)
NS-M3-20H		5.5 (0.22)	2.0 (0.08)	20.0 (0.79)
NS-M4-6H	M4	7.0 (0.28)	2.8 (0.11)	6.0 (0.24)
NS-M4-8H		7.0 (0.28)	2.8 (0.11)	8.0 (0.31)
NS-M4-10H		7.0 (0.28)	2.8 (0.11)	10.0 (0.39)
NS-M4-12H		7.0 (0.28)	2.8 (0.11)	12.0 (0.47)
NS-M4-16H		7.0 (0.28)	2.8 (0.11)	16.0 (0.63)
NS-M4-20H		7.0 (0.28)	2.8 (0.11)	20.0 (0.79)
NS-M5-6H	M5	8.0 (0.31)	3.5 (0.14)	6.0 (0.24)
NS-M5-8H		8.0 (0.31)	3.5 (0.14)	8.0 (0.31)
NS-M5-10H		8.0 (0.31)	3.5 (0.14)	10.0 (0.39)
NS-M5-12H		8.0 (0.31)	3.5 (0.14)	12.0 (0.47)
NS-M5-16H		8.0 (0.31)	3.5 (0.14)	16.0 (0.63)
NS-M5-20H		8.0 (0.31)	3.5 (0.14)	20.0 (0.79)
NS-M6-10H	M6	10.0 (0.39)	4.0 (0.16)	10.0 (0.39)
NS-M6-12H		10.0 (0.39)	4.0 (0.16)	12.0 (0.47)
NS-M6-16H		10.0 (0.39)	4.0 (0.16)	16.0 (0.63)
NS-M6-20H		10.0 (0.39)	4.0 (0.16)	20.0 (0.79)
NS-M8-10H	M8	13.0 (0.51)	5.3 (0.21)	10.0 (0.39)
NS-M8-12H	M8	13.0 (0.51)	5.3 (0.21)	12.0 (0.47)
NS-M8-16H		13.0 (0.51)	5.3 (0.21)	16.0 (0.63)
NS-M8-20H		13.0 (0.51)	5.3 (0.21)	20.0 (0.79)
NS-M10-16H	M10	16.0 (0.63)	6.4 (0.25)	16.0 (0.63)
NS-M10-20H		16.0 (0.63)	6.4 (0.25)	20.0 (0.79)
NS-M10-30H		16.0 (0.63)	6.4 (0.25)	30.0 (1.18)
NS-M10-40H		16.0 (0.63)	6.4 (0.25)	40.0 (1.57)
NS-M12-16H	M12	18.0 (0.71)	7.5 (0.30)	16.0 (0.63)
NS-M12-20H		18.0 (0.71)	7.5 (0.30)	20.0 (0.79)
NS-M12-30H		18.0 (0.71)	7.5 (0.30)	30.0 (1.18)
NS-M12-40H		18.0 (0.71)	7.5 (0.30)	40.0 (1.57)
NS-M14-20H	M14	21.0 (0.83)	8.8 (0.35)	20.0 (0.79)
NS-M14-30H		21.0 (0.83)	8.8 (0.35)	30.0 (1.18)
NS-M14-40H		21.0 (0.83)	8.8 (0.35)	40.0 (1.57)
NS-M16-40H	M16	24.0 (0.94)	10.0 (0.39)	40.0 (1.57)
NS-M16-50H		24.0 (0.94)	10.0 (0.39)	50.0 (1.97)
NS-M16-60H		24.0 (0.94)	10.0 (0.39)	60.0 (2.36)
NS-M18-40H	M18	27.0 (1.06)	11.5 (0.45)	40.0 (1.57)
NS-M18-50H		27.0 (1.06)	11.5 (0.45)	50.0 (1.97)
NS-M18-60H		27.0 (1.06)	11.5 (0.45)	60.0 (2.36)
NS-M20-40H	M20	30.0 (1.18)	12.5 (0.49)	40.0 (1.57)
NS-M20-50H		30.0 (1.18)	12.5 (0.49)	50.0 (1.97)
NS-M20-60H		30.0 (1.18)	12.5 (0.49)	60.0 (2.36)

HEX NUTS

- Provide excellent chemical resistance
- Great resistant to wear, high strength with light weight
- Material: Polyamide 6,6, UL94HB
- Color: Natural

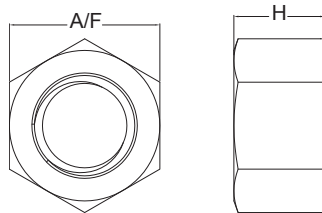

Part No.	Thread	Accross Flats (A/F) mm (inch)	H mm (inch)
NU-M3	M3	5.5 (0.22)	2.4 (0.09)
NU-M4	M4	7.0 (0.28)	3.2 (0.13)
NU-M5	M5	8.0 (0.31)	4.7 (0.19)
NU-M6	M6	10.0 (0.39)	5.2 (0.20)
NU-M8	M8	13.0 (0.51)	6.8 (0.27)
NU-M10	M10	16.0 (0.63)	8.4 (0.33)
NU-M12	M12	18.0 (0.71)	10.8 (0.43)
NU-M14	M14	21.0 (0.83)	12.8 (0.50)
NU-M16	M16	24.0 (0.94)	14.8 (0.58)
NU-M18	M18	27.0 (1.06)	15.8 (0.62)
NU-M20	M20	30.0 (1.18)	18.0 (0.71)

COMBO PACKS

* Available in different combinations



Fastening System
Combo Packs

1

1000 pcs/tube		
GT-100M	200 pcs	Natural Color
GT-100M	200 pcs	Black Color
GT-100M	300 pcs	3 color(Red, Green, Yellow) @100pcs
GT-200ST	200 pcs	Natural Color
GT-280ST	100 pcs	Natural Color
20 SETS/CTN		

850 pcs/tube		
GT-100M	100 pcs	Natural Color
GT-100M	400 pcs	Red, Blue, Yellow, Green @100 pcs
GT-200ST	300 pcs	Natural Color
GT-280ST	50 pcs	Natural Color
20 SETS/CTN		

1000 pcs/tube		
GT-100M	200 pcs	Natural Color
GT-100M	400 pcs	Red, Blue, Yellow, Green @100pcs
GT-200ST	350 pcs	Natural Color
GT-280ST	50 pcs	Natural Color
20 SETS/CTN		

650 pcs/tube		
GT-100M	100 pcs	Natural Color
GT-100M	200 pcs	Red, Blue, Yellow, Green @50 pcs
GT-200ST	300 pcs	Natural Color
GT-280ST	50 pcs	Natural Color
20 SETS/CTN		

COMBO PACKS

2

1201 pcs/tube		
GT-100M	200 pcs	Natural Color
GT-100M	200 pcs	Red, Blue, Yellow, Green @ 50 pcs
GT-200M	400 pcs	Natural Color
GT-200I	200 pcs	Natural Color
GT-300M	200 pcs	Natural Color
GIT-701	1 pcs	Orange+Black
20 SETS/CTN		

3

300 pcs/tube		
GT-100M	50 pcs	Natural Color
GT-100M	50 pcs	Black Color
GT-140I	100 pcs	Natural Color
GT-120ST	50 pcs	Red Color
GT-120ST	50 pcs	Blue Color

4

650pcs double blister		
GT-100M	200 pcs	Natural Color
GT-100M	100 pcs	Black Color
GT-200ST	100 pcs	Natural Color
GT-280ST	100 pcs	Natural Color
GT-100M	20 pcs	Blue Color
GT-100M	20 pcs	Neon Orange Color
GT-100M	20 pcs	Yellow Color
GT-100M	20 pcs	Neon Green Color
GT-100M	20 pcs	Neon Pink Color
GT-200ST	10 pcs	Red Color
GT-200ST	10 pcs	Blue Color
GT-200ST	10 pcs	Purple Color
GT-200ST	10 pcs	Yellow Color
GT-200ST	10 pcs	Black Color

5

Cable Clip /tube	
GF-2.0	300 pcs

6

Cable Clip /tube	
GC-9	80 pcs

7

Cable Tie Mounts/ bag	
HW-3A	50 pcs

8

Stainless Steel Cable Ties /bag	
Available in different quantity / size	

9

Cable Ties /bag		
GT-150I	30 pcs	Natural Color

10

Cable Ties 150pcs/bag		
GT-100M	50 pcs	Natural Color
GT-120ST	50 pcs	Natural Color
GT-200ST	50 pcs	Natural Color



Fastening System
Combo Packs

CABLE PROTECTION

WIRING DUCTS



Button Tubes



Hook & Loop Tubes



Wrapping Bands



Slotted/
Solid Wall Wiring
Ducts



Round Type Wiring
Ducts



Telephone Wiring
Ducts



One Piece
Raceway



Raceway Fittings



Multi-Cutter



Wiring Duct Cutter

TOOLS

BUSHINGS



Strain Relief
Bushings



Open Bushings



Washing Machine
Cord Bushings



Cable Clamps



Hole Plugs



Bushings



Extruded Grommeting

CONDUITS AND FITTINGS



PA Flexible
Conduits



PE Flexible
Conduits



PP Flexible
Conduits



Five-Piece Conduit
Adaptors



Angle Type
Conduit Adaptors



Quick Disconnect
Conduit Adaptors



Conduit Mounting
Brackets



Cable Glands

WIRE TERMINATION

WIRE CONNECTORS



W Series Winged
Wire Connectors



Winged Grounding
Wire Connectors



E Series Wire
Connectors



E Series High
Temperature Wire
Connectors



H Series All Plastic
Wire Connectors



C Series Close-End
Crimp Connectors



Un-Insulated
Cord-End
Terminals



Cord-End
Terminals



Twin Cord-End
Terminals

CORD-END TERMINALS

TERMINALS



Non-Insulated Ring
Terminals



Non-Insulated
Ring Terminals
(DIN Standard)



Vinyl-Insulated Ring
Terminals



Vinyl-Insulated
Ring Terminals
(DIN Standard)



Non-Insulated
Spade Terminals



Vinyl-Insulated
Spade Terminals



Vinyl-Insulated Pin
Terminals



Vinyl-Insulated
Female
Disconnectors



Vinyl-
Insulated Male
Disconnectors

TOOLS



Vinyl-Fully
Insulated Female
Disconnectors



Vinyl-Insulated
Piggyback
Disconnectors



Vinyl-Insulated
Male Bullet
Connectors



Vinyl-Fully
Insulated Female
Bullet Connectors



Vinyl-Insulated Butt
Splices



Quick Splices



Tools for Cord-End
Terminals



Tools for Terminals



Tools for Close-
End Crimp
Connectors

SECURITY SEALS



Bag Seals



Multi-Purpose Bag
Seals



Hua Wei Industrial Co., Ltd. is a leading manufacturer of wire and cable management products in the world. Since 1976, Hua Wei has delivered excellence by consistently providing customers with extraordinary quality, first-class customer service, competitive pricing, and timely delivery. With rich experience and expertise, Hua Wei's global reach and presence is unmatched in the industry.

Headquartered in Taichung Taiwan, Hua Wei has expanded its manufacturing operations overseas in China and Thailand that are vertically integrated in design, manufacturing, processing, assembly, and packaging, thus expediting its response to changes in customer needs and market requirements. Moreover, all of Hua Wei manufacturing facilities are certified to ISO/TS16949, ISO9001, and ISO14001, complying with top-level quality systems and minimizing environmental impacts.

Hua Wei offers exceptional service combined with a large selection of products for a variety of applications in electrical, electronics, telecommunications, automotive, shipbuilding, rail, energy, construction, and retailing industries. In addition, to meet industry needs and market requirements, Hua Wei's products have gained UL, CE, CSA, ABS, DNV GL, BV and CQC accreditations and are all compliant with RoHS and REACH regulations.

Building its competitive advantage upon the core goals of innovation, continuous improvement and complete customer satisfaction, Hua Wei always spares no effort in advanced research and development to maintain its leading position and continually invests in its manufacturing operations to ensure customers receive the highest quality products and services.



HUA WEI INDUSTRIAL CO., LTD.

HEADQUARTERS

NO.1, GONGYEQU 26TH RD., NANTUN DIST.,
TAICHUNG CITY, 40850, TAIWAN
TEL: +886-4-23597777
FAX: +886-4-23596705~6
Email: service@hwlok.com
<http://www.hwlok.com>